

Bivocom[®]

Industrial 5G/4G Gigabit IoT Gateway TG465 Series User Guide



Copyright

Copyright © XIAMEN BIVOCOM TECHNOLOGIES CO., LTD. All rights reserved.

Trademark

BIVOCOM logo is a registered trademark of Xiamen Bivocom Technologies Co., Ltd. All other trademarks belong to their respective vendors or manufactures.

Disclaimer

Product specifications and information in this document are subject to change without any notice, and BIVOCOM reserves the right to improve and change this user guide at any time. Users should take full responsibility for their application of products, and Xiamen Bivocom Technologies Co., Ltd. disclaims all warranties and liability for the accurateness, completeness of the information published.

Global Technical & Sales Support

Bivocom

Xiamen Bivocom Technologies Co., Ltd.

Addr: Unit 1402, No. C07 Building, 3rd Software Park, Xiamen, China 361000

Tel.: +86-592-6090 133

Fax: +86-592-6211727

Email: support@bivocom.com

sales@bivocom.com

www.bivocom.com



EU DECLARATION OF CONFORMITY

Hereby, **Xiamen Bivocom Technologies Co., Ltd.** declares that the radio equipment type TG465 is in compliance with Directive 2014/53/EU.

About This Guide

Thank you for choosing Bivocom Industrial 5G/4G Gigabit IoT Gateway TG465 Series.

Please thoroughly read this user guide before you configure and install the device.

This manual is compatible with below models

Model	Description
TG465-NR	Industrial Edge Gateway with 5G/NR
TG465-LF	Industrial Edge Gateway with 4G/LTE

Table of Contents

Copyright	1
Trademark	2
Disclaimer	2
About This Guide	2
Table of Contents	4
1. Introduction	6
1.1 Overview	6
1.2 Applications	6
1.3 Dimensions	7
1.4 Physical Characteristics	7
2. Getting Started	7
2.1 Package Checklist	7
2.2 Installation	8
2.2.1 SIM/UIM Card	9
2.2.2 Interfaces connection	9
2.2.3 Power Supply	10
2.2.4 Cellular Antenna	10
2.3 LED Indicators	10
3. Configuration and Management	11
3.1 View	12
3.1.1 System	12
3.1.2 Network	12
3.1.3 Routing Tables	13
3.1.4 System Log	14
3.1.5 VPN Status	14
3.2 Setup	15
3.2.1 WAN	15
3.2.2 LAN	17
3.2.3 Wireless (Option)	18
3.2.4 Online Detection	20
3.2.5 Diagnostics	22
3.3 Security	23
3.3.1 DMZ Host	23
3.3.2 Port Forwarding	24
3.3.3 Traffic Rules	24
3.3.4 Custom Settings	26
3.4 VPN	26
3.4.1 PPTP	26
3.4.2 L2TP	28
3.4.3 OpenVPN	31

3.4.4 IPsec	32
3.5 Advanced	33
3.5.1 Static Routing	33
3.5.2 Net Flow	34
3.5.3 GPS Location	34
3.5.4 DHCP and DNS	35
3.6 Data Collect	35
3.6.1 Basic Setting	35
3.6.2 Interface Setting	36
3.6.3 Modbus Rules Setting	37
3.6.4 IO Setting	38
3.6.5 Server Setting	41
3.7 Administrate	42
3.7.1 System	42
3.7.2 Password	43
3.7.3 Time Setting	44
3.7.4 Log Settings	45
3.7.5 Backup and Reset	46
3.7.6 Firmware Upgrade	47
3.7.7 Remote Management	48
3.7.8 Manual Reboot	49
3.7.9 Schedule Reboot	50

1. Introduction

1.1 Overview

The TG465 is a powerful and intelligent next generation IoT Gateway built-in with ARM CPU, GPU and NPU. It's designed for mission-critical IoT applications that demands advanced connectivity, edge computing, enhanced security, AI and machine learning, improved energy efficiency. It finds great utility in sectors such as industry 4.0, telecom sites, smart city, smart grid, renewable energy, transportation, etc.

The TG465 offers an embedded environment with OpenWRT-based Linux OS, enabling IoT developers to program and install their own applications using Python, C/C++ directly on the hardware via SDK. Additionally, it provides a flexible secondary development option through the Ubuntu programming environment.

The TG465 has wide range of interfaces and I/Os, allowing seamless connectivity with various equipment, controllers, and sensors. It facilitates data transfer to the cloud server via a 5G/4G LTE cellular network. It also supports crucial industrial protocols like MQTT broker/client, Modbus RTU/TCP, JSON, TCP/UDP, OPC UA, IEC101/104, and VPN, ensuring efficient and secure IoT data connectivity between field devices and the cloud server..

1.2 Applications

The TG465 facilitates quick access to high-speed internet and ensures secure and reliable data transmission. It has found widespread applications in smart pole scenarios, including smart cities, municipal areas, parks, highways, tunnels, scenic areas, industrial parks, and themed towns.

Typical application as below.

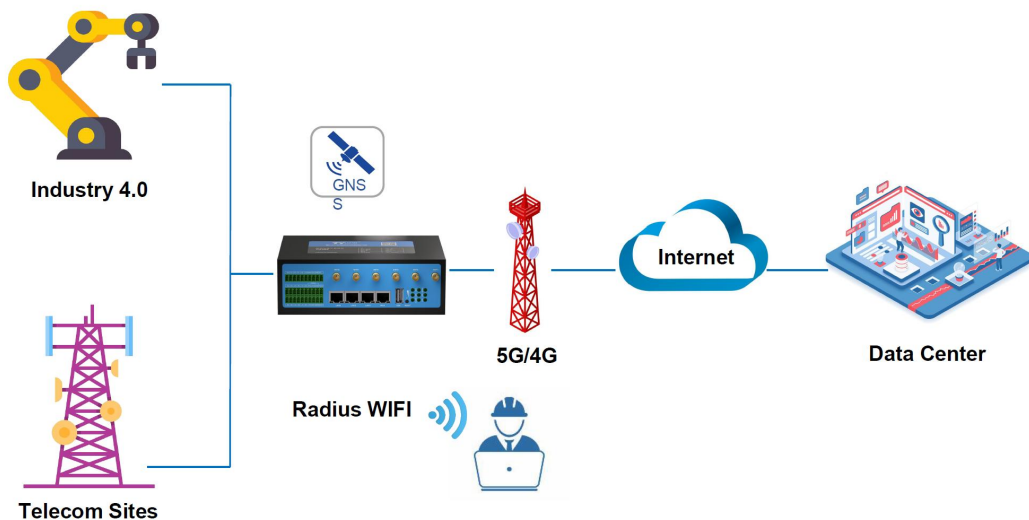

1.3 Dimensions

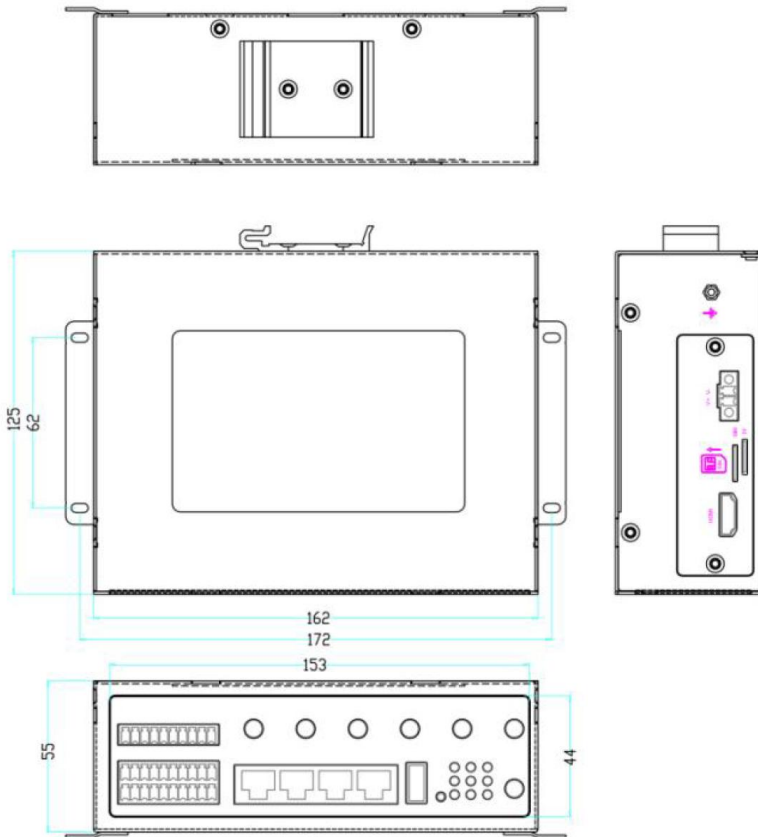

1.4 Physical Characteristics

Physical Characteristics	
Housing	Metal, IP30
Dimensions	162x125x55mm (6.38 x 4.92 x 2.16in), Antenna and other accessories not included
Weight	TG465: 799g (1.76lbs), without accessories.

2. Getting Started

2.1 Package Checklist

The following components are included in your TG465 package.

Check the list before installation. If you find anything missing, Please feel free to contact Bivocom.

- | | | |
|----------------------------------------------------------|------|--------------------------------------|
| 1. TG465 Gateway | 1PCS | |
| 2. Power Adapter(DC 12V/1.5A, EU/US/UK/AU plug optional) | | 1PCS |
| 3. Mag-mount Cellular Antenna (SMA Male, 1 meter, 5dBi) | | 5G Version:4 PCS
4G Version:2 PCS |
| 4. RS232 Cable (DB9 Female, 1 meter) | 1PCS | |
| 5. Ethernet Cable (1 meter) | 1PCS | |
| 6. 10-Pin Terminal Block | 3PCS | |
| 7. 2-Pin Terminal Block | 1PCS | |
| 8. DIN-Rail Mount Kits | 1PCS | |

2.2 Installation

Hardware interfaces instruction:

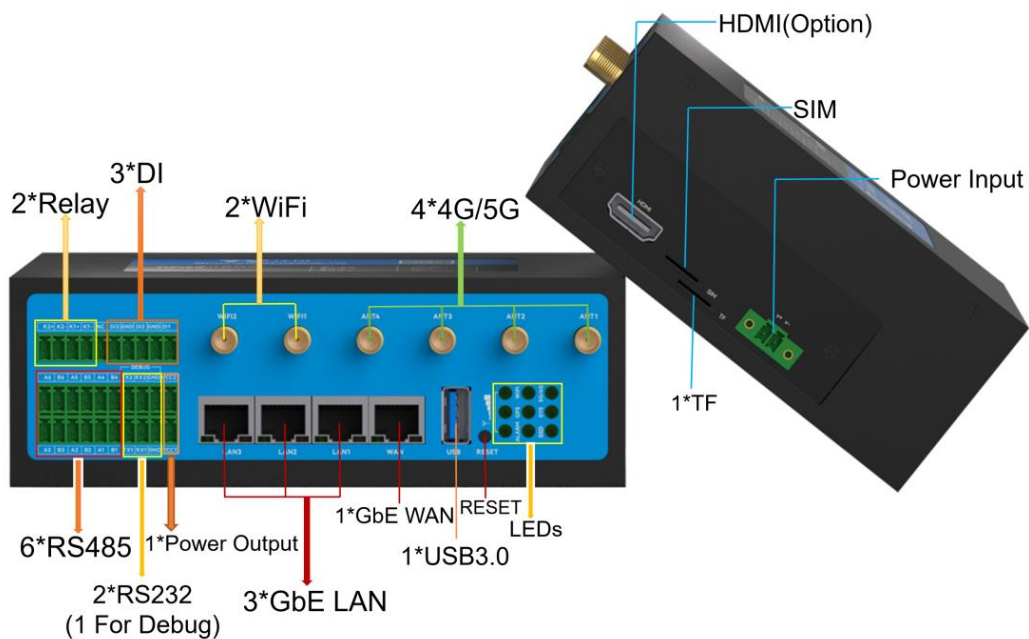

Interfaces

Terminal Block 1	K2+	K2-	K1+	K1-	NC	DI3	GND	DI2	GND	DI1
	Relay 2		Relay 1			DI 1-3				
Terminal Block 2	RS485-6		RS485-5		RS485-4		Debug			Power Output 2
	A6	B6	A5	B5	A4	B4	TX2	RX2	GND	VCC2
Terminal Block 3	A3	B3	A2	B2	A1	B1	TX1	RX1	GND	VCC1
	RS485-3		RS485-2		RS485-1		RS232			Power Output 1

LED Indicators	Signal Strength	WIFI	5G/4G
		GPS	SYS
		ALARM	SSD

Ethernet Ports	LAN3	LAN2	LAN1	WAN
----------------	------	------	------	-----

Antenna Ports	5G: ANT 1-4 4G: ANT 1-2			
	ANT4	ANT3	ANT2	ANT1

2.2.1 SIM/UIM Card

TG465 supports normal SIM/UIM only, so if you're using a Micro SIM or Nano SIM card, you may need to use a Micro SIM or Nano SIM to Normal SIM adapter.

Make sure your router is powered off, then use a needle object(such as a pen) to push the button near the SIM/UIM card holder, it will flick out immediately. Put the SIM/UIM card to card holder with chipset upside, insert it to router and make sure it's tightly matched.

Warning: Never install SIM/UIM card when router is powered on.

2.2.2 Interfaces connection

TG465 support 2 RS232 serial ports, 1 RS232_2 works as console port, which can be used for firmware upgrade, system log checking, debug, etc, 1 RS232_1 can be used for communicating and data collecting.

TG465 include 6 RS485, 2x Relay (K1, K2), 3x DI(DI_1, DI_2, DI_3), 1 x 12V DC Output power supply.

There are 2 Relays, K1/K2, they are mainly used to control switching circuits, 3XDI are mainly used to detect high or low-level output(PREVP) voltage.

Relay Interface (K1, K2)

Relay Feature	Control the external switch
Load capacity	Maximum Voltage switch: 30VDC/250VAC Maximum Current switch: 5A

DI Interface (DI1, DI2, DI3)

DI Feature	Detect the slave device status
Input Range	Logic 0: wet contact 5-30VDC, or dry contact close. Logic 1: wet contact 0-3VDC, or dry contact open.

RS485 Cable (RS485_1~6)

Color of cable	TG465 Gateway
Red	(A)
Black	(B)

2.2.3 Power Supply

We suggest you use Bivocom standard power adapter (1.5A/12VDC). If you have to use your own power supply, make sure the power range is 5-35VDC and it is stable enough(Ripple shall be less than 300mV, and Instantaneous voltage shall not larger than 35V), meanwhile, power shall over 4W.

2.2.4 Cellular Antenna

Screw the SMA male antenna to TG465(SMA female port), make sure it is screwed tightly to ensure the strength of signal.

2.3 LED Indicators

TG465 Series Gateway provides 8 LED indicators, as following.

Indicator	Status	Content
Power	On	Powered On
	Off	Powered Off
ALARM	ON	SIM/UIM doesn't insert or broken, weak signal
	Blink every 1s	Cellular module doesn't detected
SYS	Blink	System works perfect
	Off	System doesn't work
4G/5G	On	Connected to 4G/5G Network
	Off	Doesn't connect to 4G/5G Network
WiFi	On	WiFi enabled
	Off	WiFi disabled
GPS	On	Gateway got GPS data successfully
	Off	Gateway failed in getting GPS data

3. Configuration and Management

Use an Ethernet cable to connect the LAN port of TG465 to your laptop, or use your laptop or mobile phone to connect to WIFI hotspot 'Bivocom' of TG465, login with password: admin123, normally your laptop will get an IP address from TG465 DHCP as 192.168.1.xx, otherwise please manually configure your laptop IP to 192.168.1.100. Open browser, enter 192.168.1.1 to enter into to login page, enter username: admin, and password: admin, to go to configuration page.

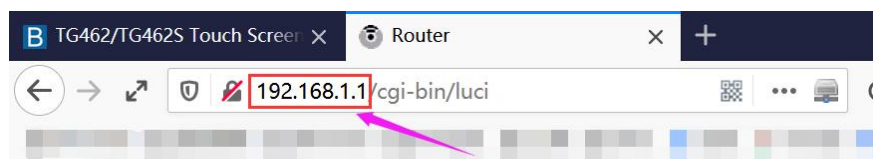

Authorization Required

Please enter your username and password.

Username

Password

3.1 View

To check the following system information.

3.1.1 System

Display system related information.

> View	Status
> Setup	
> Secure	System
> VPN	Hostname router
> Advanced	Model TG465
> Data Collect	SN 23092000059
> Administrate	Firmware Version 1.0.0.4
> Debug	Release Time 2024-04-18 11:34:31
Logout	Local Time 2024-05-27 13:54:21 Monday
	Uptime 0h 0m 33s
	Load Average 0.50, 0.13, 0.04
	Memory
	Total Available 7783004 kB / 7858820 kB (99%)
	Free 7763224 kB / 7858820 kB (98%)
	Cached 18264 kB / 7858820 kB (0%)
	Buffered 1516 kB / 7858820 kB (0%)

3.1.2 Network

Display WAN, LAN, WiFi, DHCP network information.

- ✓ **View**
- System
- Network**
- Routes
- System Log
- VPN Status
- > **Setup**
- > **Secure**
- > **VPN**
- > **Advanced**
- > **Data Collect**
- > **Administratrate**
- Logout

Status

Network

IPv4 WAN Status

 **Type:** dhcp
 eth1 **Address:** 172.17.144.186
Netmask: 255.255.255.0
Gateway: 172.17.144.1
Mac Address: 72:1e:c8:85:ed:6e
DNS 1: 172.17.144.1
Connected: 8h 16m 58s

Online Status online

Active Connections 29 / 16384 (0%)

LAN Status

IP Address 192.168.1.1

Netmask 255.255.255.0

DHCP Server Enable

Mac Address 00:52:24:12:24:f8

Wireless Status

Wireless Enable

SSID top-iot

Channel 10

Mac Address 0c:8c:24:8f:34:e6

DHCP Leases

Hostname	IPv4-Address	MAC-Address
HARRY-TP	192.168.1.152	00:e0:4c:68:0b:1e

3.1.3 Routing Tables

Display routing tables.

ARP

IPv4-Address	MAC-Address	Interface
192.168.1.100	1c:39:47:3f:28:1d	br-lan

Active IPv4-Routes

Network	Target	IPv4-Gateway	Metric
lan	192.168.1.0/24	0.0.0.0	0

Active IPv6-Routes

Network	Target	IPv6-Gateway	Metric
loopback	0:0:0:0:0:0:0:0/0	0:0:0:0:0:0:0:0/0	FFFFFFFF
loopback	0:0:0:0:0:0:0:1	0:0:0:0:0:0:0:0/0	00000000
(eth2)	FF00:0:0:0:0:0:0:0/8	0:0:0:0:0:0:0:0/0	00000100
lan	FF00:0:0:0:0:0:0:0/8	0:0:0:0:0:0:0:0/0	00000100
(ra0)	FF00:0:0:0:0:0:0:0/8	0:0:0:0:0:0:0:0/0	00000100
wan	FF00:0:0:0:0:0:0:0/8	0:0:0:0:0:0:0:0/0	00000100
loopback	0:0:0:0:0:0:0:0/0	0:0:0:0:0:0:0:0/0	FFFFFFFF

3.1.4 System Log

Display system log.

View

- System
- Network
- Routes
- System Log
- VPN Status

Setup

Secure

VPN

Advanced

Data Collect

Administrate

Logout

System Log

Clear Log Save Log Refresh Log

```
Jul 16 16:42:55 monitord[1210]: proto is dhcp, ifname is eth1
Jul 16 16:43:55 monitord[1210]: ping 114.114.114.114, return online
Jul 16 16:43:55 monitord[1210]: proto is dhcp, ifname is eth1
Jul 16 16:44:55 monitord[1210]: ping 114.114.114.114, return online
Jul 16 16:44:55 monitord[1210]: proto is dhcp, ifname is eth1
Jul 16 16:45:55 monitord[1210]: ping 114.114.114.114, return online
Jul 16 16:45:55 monitord[1210]: proto is dhcp, ifname is eth1
Jul 16 16:46:56 monitord[1210]: ping 114.114.114.114, return online
Jul 16 16:46:56 monitord[1210]: proto is dhcp, ifname is eth1
Jul 16 16:47:56 monitord[1210]: ping 114.114.114.114, return online
Jul 16 16:47:56 monitord[1210]: proto is dhcp, ifname is eth1
Jul 16 16:48:56 monitord[1210]: ping 114.114.114.114, return online
Jul 16 16:48:56 monitord[1210]: proto is dhcp, ifname is eth1
Jul 16 16:49:56 monitord[1210]: ping 114.114.114.114, return online
Jul 16 16:49:56 monitord[1210]: proto is dhcp, ifname is eth1
```

3.1.5 VPN Status

Display VPN status.

VPN

VPN Status

Type: l2tp

IP Address: 100.100.100.95

Netmask: 255.255.255.255

Gateway: 100.100.100.1

Connected Time: 1m,2s

3.2 Setup

Main menu of this page includes, WAN, LAN, Wireless, Online Detection, Diagnostics.

3.2.1 WAN

WAN supports DHCP/Static IP/PPPoE/5G/LTE connection mode.

Choose the mode you need, and configure the related parameters, then click 'Save&Apply', after a while, you should able to connect to the internet.

> **View**

∨ **Setup**

- WAN
- LAN
- Wireless
- Wireless Client
- Online Detection
- Diagnostics

> **Secure**

> **VPN**

> **Advanced**

> **Administrate**

Logout

Interfaces - WAN

On this page you can configure the network interfaces. You can bridge several interfaces by ticking the "bridge interfaces" field and enter the names of several network interfaces separated by spaces. You can also use VLAN notation `INTERFACE.VLANNR` (e.g.: `eth0.1`).

Common Configuration

General Setup | Physical Settings

Protocol:

Service Type:

APN:

PIN:

Username:

Password:

Authentication Type: None PAP CHAP

1) Server Type

Type of network, the default value is AUTO, you can keep it or choose your own

preference.

2) APN

Different carrier might have different APN, please ask your carrier if you have no idea of what your APN is.

3) PIN

PIN code of SIM card, please use it carefully, or the SIM card may be locked.

4) PAP/CHAP Username

Only for private network SIM card, if you're using public network SIM card, just keep it as null.

5) PAP/CHAP Password

Only for private network SIM card, if you're using public network SIM card, just keep it as null.

6) Call Center No.

When you're using SIM card, different carrier may have different call center Number, please ask your carrier for this info if you have questions.

7) Authentication Type

If there have username and password, you need to choose authentication type.

- PAP, Plaintext Authentication
- CHAP, Handshake authentication

You need to choose the authentication type according to carrier's network, or you may fail to dial up.

8) WAN Used As LAN

When you use 5G/4G/3G cellular network to access internet, you can change the WAN to act as a LAN port.

> **View**
 > **Setup**
 WAN
 LAN
 Wireless
 Online Detection
 Diagnostics
 > **Secure**
 > **VPN**
 > **Advanced**
 > **Data Collect**
 > **Administrative**
 Logout

WAN Setting

On this page, you can configure WAN port connection type

WAN Interface

General Settings Advanced Settings

Clone MAC Address

MTU ⓘ (64-1500)

WAN Multiplex ⓘ Set WAN port as LAN port

3.2.2 LAN

Menu of LAN are mainly for configuring IP address of router, enabling DHCP server, and assign the IP address.

The meaning of the parameters are as follows.

Common Configuration

General Setup Advanced Settings Physical Settings

Protocol

IPv4 address

IPv4 netmask

IPv4 gateway

DNS Servers

1) IPv4 Address

To configure IP address of LAN port.

2) IPv4 Netmask

The netmask of LAN port IP address.

3) IPv4 Gateway

Specify the next-hop routing gateway.

4) DHCP Settings

General Setup

Ignore interface [? Disable DHCP for this interface.](#)

Start [? Lowest leased address as offset from the network address.](#)

Limit [? Maximum number of leased addresses.](#)

Leasetime [? Expiry time of leased addresses, minimum is 2 minutes \(2m\).](#)

- **Disable DHCP**

Click to disable DHCP server.

- **Start**

Assign the IP address of DHCP server. For example, 100 means IP address starts from 192.168.1.100.

- **Limit**

Assignable number of IP address, to ensure numbers of IP address of start and limit not exceed 250.

- **Lease time**

Time of assigning the IP address.

3.2.3 Wireless (Option)

Menu of wireless are mainly for configuring the SSID, work mode, password, etc.

Note, WiFi is not be included in standard TG465, please ask Bivocom representative when place the order.

WiFi 2.4G Enable Disable

Network Name(SSID)

Channel

Mode

Encryption

Key 

Hide SSID

1) WIFI 2.4G

Click 'Enable', to enable the WIFI function.

2) Network Name (SSID)

WIFI network name.

3) Channel

Support 1-13 channels, default value is auto, channel can be changed automatically.

4) Mode

Support 802.11b, 802.11g, 802.11bgn.

802.11b up to 11Mbps, 802.11g up to 54Mbps and 802.11n up to 300Mbps.

5) Encryption

You can only choose below types if the mode is set as 802.11b or 802.11g.

WPA2-PSK-AES	▼
No Encryption	
WPA2-AES-RADIUS	
WPA2-PSK-AES	
WPA-PSK-AES	

6) Key

Password of sharing the WIFI, user need to enter it to access the internet. The minimum length of password is 8 bytes.



7) Hide SSID

When Hide SSID enabled, SSID is invisible, and user need to enter the SSID to share the WIFI.

3.2.4 Online Detection

Online detection will auto check the internet connection status of the router, if there has issue of connection, router will auto reconnect. If it fails to reconnect after times of trial, router will reboot, to ensure getting online.

The meaning of the parameters are as follows.

Online Detection	<input checked="" type="radio"/> Enable <input type="radio"/> Disable
Detection Type	<input type="text" value="Ping"/> ▼
Primary Detection Server	<input type="text" value="114.114.114.114"/>
Second Detection Server	<input type="text" value="202.96.199.133"/>
Retry Times	<input type="text" value="3"/>
Retry Interval	<input type="text" value="60"/>  Seconds
Enable Reboot	<input checked="" type="radio"/> Enable <input type="radio"/> Disable
Reboot After Interval	<input type="text" value="10"/>  Minutes

1) Detection Type

There are 3 types: ping, traceroute and DNS.

- **Ping**

Router will ping an IP address or DNS, if works, that means router is online.

- **Traceroute**

Traceroute will trace routing path, if achieves the target address, that means router is online.

- **DNS**

DNS will analytic a domain, if it works, that means router is online.

Note: the default setting is Ping, which is highly recommended, as traceroute will cost dataflow of SIM card, while DNS is faster, but as it has cache, it may shows the router is online even it is offline.

2) Primary Detection Server

It can be an IP address or a Domain Name.

3) Second Detection Server

If primary detection server fails, then router will auto switch to second detection server.

4) Retry Times

You can set up retry time in case detection fails.

5) Retry Interval

The interval time between 2 detection.

6) Enable Reboot

Click enable, and router will reboot within the time set if it fails to reconnect.

7) Reboot After Interval

You can specify the time for offline, to reboot the router.

3.2.5 Diagnostics

There are 3 types of diagnostics: ping, traceroute and nslookup

Parameter of ping and traceroute can be a Domain Name or an IP address, used for checking if router is online or not. While nslookup is to analytic domain.

1) Ping

Click ping, then you can check if there is response from an IP address, as bellow.



The screenshot shows a web-based diagnostic tool with three input fields: '114.114.114.114', '114.114.114.114', and 'www.baidu.com'. Below each field are buttons for 'IPv4', 'Ping', 'Traceroute', and 'Nslookup'. The 'Ping' button for the first field is highlighted. Below the buttons, there is a message: 'Install iputils-traceroute6 for IPv6 traceroute'. The main output area displays the following text:

```
PING 114.114.114.114 (114.114.114.114): 56 data bytes
64 bytes from 114.114.114.114: seq=0 ttl=70 time=881.904 ms
64 bytes from 114.114.114.114: seq=1 ttl=72 time=88.259 ms
64 bytes from 114.114.114.114: seq=2 ttl=86 time=96.134 ms
64 bytes from 114.114.114.114: seq=3 ttl=92 time=88.011 ms
64 bytes from 114.114.114.114: seq=4 ttl=81 time=76.243 ms

--- 114.114.114.114 ping statistics ---
5 packets transmitted, 5 packets received, 0% packet loss
round-trip min/avg/max = 76.243/246.110/881.904 ms
```

2) Traceroute

Click traceroute, then you can see similar reponse as below.

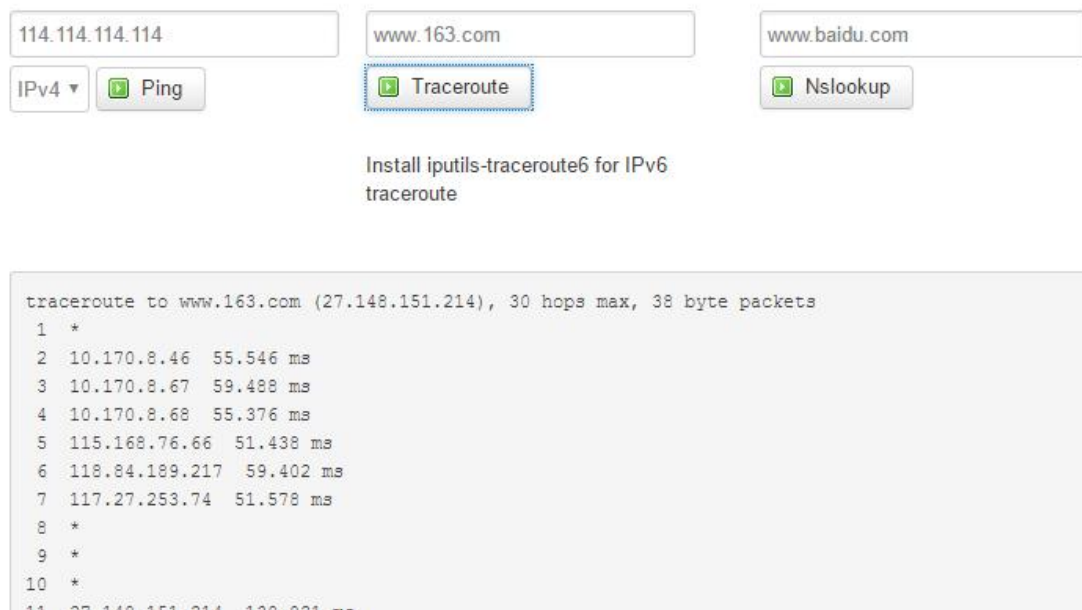

The screenshot shows the same web-based diagnostic tool. The 'Traceroute' button for the second input field 'www.163.com' is highlighted. Below the buttons, there is a message: 'Install iputils-traceroute6 for IPv6 traceroute'. The main output area displays the following text:

```
traceroute to www.163.com (27.148.151.214), 30 hops max, 38 byte packets
 1 *
 2 10.170.8.46 55.546 ms
 3 10.170.8.67 59.488 ms
 4 10.170.8.68 55.376 ms
 5 115.168.76.66 51.438 ms
 6 118.84.189.217 59.402 ms
 7 117.27.253.74 51.578 ms
 8 *
 9 *
10 *
11 27.148.151.214 139.821 ms
```

3) Nslookup

Click nslookup, then you can see similar reponse as below.

The screenshot shows a network utility interface with three columns of input fields and buttons. The first column has the IP address '114.114.114.114', a dropdown menu set to 'IPv4', and a 'Ping' button. The second column has the domain 'www.163.com' and a 'Traceroute' button. The third column has the domain 'www.baidu.com' and an 'Nslookup' button. Below these fields is a text instruction: 'Install iputils-traceroute6 for IPv6 traceroute'. At the bottom, a text box displays the output of the nslookup command for 'www.baidu.com':

```
Server: 127.0.0.1
Address 1: 127.0.0.1 localhost

Name: www.baidu.com
Address 1: 14.215.177.38
Address 2: 14.215.177.37
```

3.3 Security

Menu of Security are for configuring the firewall, to ensure the security of accessing to internet, and implement the port forwarding, access control, data packet filtering, and other functions.

3.3.1 DMZ Host

DMZ can forward the port of WAN to a host of LAN; all packet from WAN will be forwarded to specified host of LAN.

The screenshot shows the DMZ configuration interface. It includes a 'DMZ' label followed by two radio buttons: 'Enable' (which is selected) and 'Disable'. Below this is a 'DMZ Host' label followed by a text input field containing the IP address '192.168.1.0'.

1) DMZ

You can enable or disable the DMZ.

2) DMZ Host

An IP address of a host of LAN you want to map.

3.2.2 Port Forwarding

Comparing with DMZ, Port Forwarding is for more precise control, user can forward the data packet of a port to a host of LAN, to forward different port to different host.

New port forward:					
Name	Protocol	External zone	External port	Internal IP address	Internal port
<input type="text" value="New port forward"/>	TCP+ <input type="text"/>	wan <input type="text"/>	<input type="text"/>	<input type="text"/>	<input type="text"/>
					 Add

1) Name

You can name the rule you created.

2) Protocol

You can choose TCP, UDP, or TCP/UDP.

3) External Port

Destination port before port forwarding.

4) Internal IP Address

The Host IP address to forward.

5) Internal Port

The destination port after port forwarding. Normally, external port and internal port are the same, but also can be different.

After configured above-mentioned, click 'Add', then a new rule will be added, and click 'Save & Apply', to have the rule take effect.

3.3.3 Traffic Rules

Traffic rules is used for opening some router ports, such as remote access the configuration page of router, you can open port 80; for remote SSH connection, you can open port 22.

Open ports on router:		
Name	Protocol	External port
<input type="text" value="New input rule"/>	TCP+UDP <input type="text"/>	<input type="text"/>
		 Add

1) Name

You can name the rule yourself.

2) Protocol

Choose the protocol of you want to forward can be TCP, UDP, or TCP/UDP.

3) External Port

Choose the port you want to open.

In addition, traffic rule can be used for creating some access control rules, it can be from LAN to WAN, or WAN to LAN.

New forward rule:

Name	Source zone	Destination zone	
<input type="text" value="New forward r"/>	<input type="text" value="lan"/>	<input type="text" value="wan"/>	<input type="button" value="Add and edit"/>

1) Name

You can name the rule yourself.

2) Source Zone

You can choose where to start the data packet.

3) Destination Zone

You can choose where to forward the data packet.

Click 'Add and Edit', then you can get more detailed matching condition.

Rule is enabled

Name

Restrict to address family

Protocol

Match ICMP type

Source zone

Any zone

lan: lan:

wan: wan:

Source MAC address

Source address

Source port

Destination zone

Device (input)

Any zone (forward)

lan: lan:

wan: wan:

Destination address

Destination port

Action

Extra arguments Passes additional arguments to iptables. Use with care!

1) Restrict to Address Family

You can choose IPv4, IPv6, or Pv4/IPv6.

2) Protocol

To choose the protocol you want for access control, it can TCP, UDP or TCP/UDP.

3) Source MAC Address

To choose the source MAC address of data packet.

4) Source Address

To choose the source IP address of data packet.

5) Source Port

To choose the source port of data packet.

6) Destination Address

To choose the destination IP address of data packet.

7) Destination Port

To choose the destination port of data packet.

8) Action

If the above-mentioned conditions matched, then you can choose below actions.

- **Accept**

Allow data packet to go through.

- **Drop**

Drop data packet

- **Reject**

Drop data packet, and return an unachievable data packet.

- **Don't Track**

No action.

3.3.4 Custom Settings

Users can also customize some firewall rules themselves, as those rules consist of iptable, we suggest users that are familiar with iptables command to do this. When you add rules, please add them at the bottom of existing rules, and don't delete them.

3.4 VPN

VPN is used to establish a virtual private channel, and all the data in this channel will be encrypted to ensure that data security during transmission.

TG465 support VPN: PPTP, L2TP, OpenVPN and IPSec. PPTP/L2TP are layer 2 VPN, and OpenVPN is VPN based on SSL, while IPSec layer 3 VPN. PPTP/L2TP are more convenient to use, while OpenVPN and IPSec is more complex, as they need complex certification management, meanwhile, they offer more secured encrypted data.

3.4.1 PPTP

You can configure either PPTP client or PPTP server, but not both of them at the same time, as that may cause uncertain issues.

1) PPTP Client

PPTP Client Enable Disable

Server Address

User Name

Password 

Remote Subnet

Remote Subnet Mask

NAT

Enable MPPE Encryption

Enable Static Tunnel IP Address

Default Gateway  All Traffic Will Passthrough Via VPN

1. PPTP Client

You can enable or disable PPTP client.

2. Server Address

To enter the IP address or Domain Name of PPTP server.

3. User Name and Password

To enter the user name and password provided by server.

4. Remote Subnet

To enter the remote subnet, for example, if LAN of PPTP server is 192.168.2.1, then you can enter remote subnet 192.168.2.0.

5. Remote Subnet Mark

To enter the remote subnet mask, normally it is 255.255.255.0.

6. NAT

If click NAT, all packets come from ppp0, and the source IP of the packets will be replaced as IP of ppp0.

7. Enable MPPE Encryption.

You can enable MPPE encryption here.

8. Default Gateway

Click Default Gateway, then a default route will be established under ppp0, and all the data will go through this route.

2) PPTP Server

PPTP Server Enable Disable

Server Local IP

IP Address Range

Enable MPPE Encryption

DNS1

DNS2

WIN1

WIN2

CHAP Secrets

1. PPTP Server

You can enable or disable PPTP server.

2. Server Local IP

To enter the server local IP address.

3. IP Address Range

Type the range of assigned IP address.

4. Enable MPPE Encryption.

You can enable MPPE encryption here.

5. DNS1/DNS2

To enter the assigned DNS address.

6. WIN1/WIN2

To enter the WIN address.

7. CHAP Secrets

To create an username and password under CHAP Secrets, format as below,
Username<space>*<space>password<space>*

For example, if you want to create a username: test, password: test, it is as below,
Test * testing *

3.4.2 L2TP

You can also configure either L2TP client or L2TP server, but not both of them at the same time, as that may cause uncertain issues.

1) L2TP Client

L2TP Client Enable Disable

Server Address

User Name

Password 

Remote Subnet

Remote Subnet Mask

NAT

Enable MPPE Encryption

Enable Static Tunnel IP Address

Default Gateway  All Traffic Will Passthrough Via VPN

1. L2TP Client

You can enable or disable L2TP client.

2. Server Address

To enter the IP address or Domain Name of L2TP server.

3. User Name and Password

To enter the user name and password provided by server.

4. Remote Subnet

To enter the remote subnet, for example, if LAN of L2TP server is 192.168.2.1, then you can enter remote subnet 192.168.2.0.

5. Remote Subnet Mark

To enter the remote subnet mask, normally it is 255.255.255.0.

6. NAT

If click NAT, all packets come from ppp0, and the source IP of the packets will be replaced as IP of ppp0.

7. Enable MPPE Encryption.

You can enable MPPE encryption here.

8. Default Gateway

Click Default Gateway, then a default route will be established under ppp0, and all the data will go through this route.

2) L2TP Server

L2TP Server Enable Disable

Server Local IP

IP Address Range eg:10.10.10.100-10.10.10.200

Enable MPPE Encryption

CHAP Secrets

1. L2TP Server

You can enable or disable L2TP server.

2. Server Local IP

To enter the server local IP address.

3. IP Address Range

Type the range of assigned IP address.

4. Enable MPPE Encryption.

You can enable MPPE encryption here.

5. CHAP Secrets

To create an username and password under CHAP Secrets, format as below,

Username<space>*<space>password<space>*

For example, if you want to create a username: test, password: test, it is as below,

Test * test *

3.4.3 OpenVPN

OpenVPN Enable Disable

Topology

Protocol

Port

Device Type

Peer Address

Authentication Type

Local Tunnel Address

Peer Tunnel Address

Peer Subnet Address

Peer Subnet Mask

Enable NAT

Enable LZO Compress

Cipher Algorithm

MTU

1) OpenVPN

You can enable or disable OpenVPN.

2) Topology

Choose the topology, it can be point to point or subnet

Note: For point to point, a tunnel will be established between 2 devices.

While for subnet, multi devices will be connected to one server.

3) Role

When topology is subnet, you need to choose you want it be a server or client.

4) Protocol

Choose the protocol, it can be UDP or TCP, default is UDP.

5) Port

Enter the port you want to assign to OpenVPN, default port is 1194.

6) Device Type

Choose device type, there are 2 types to choose, TUN and TAP. TUN is layer 3 data encapsulation, while TAP is layer 2 data encapsulation.

7) OpenVPN Server

When you choose server in Role, you need to enter an IP address or domain name of server.

8) Authentication Type

If topology is subnet, authentication type is certification. If it is point to point, you can choose none, certificate or static secret.

9) TLS Role

When topology is point to point, and authentication type is certification, you need to choose if it is server or client.

3.4.4 IPSec

On IPSEC page, system will display the IPSEC connection and status.

IPSec Enable Disable

Peer Address	<input type="text" value="%any"/>
Negotiation Method	<input type="text" value="Main"/>
Tunnel Type	<input type="text" value="Site To Site"/>
Local Subnet	<input type="text" value="192.168.4.0/24"/>
Peer Subnet	<input type="text" value="192.168.5.0/24"/>
IKE Encryption Algorithm	<input type="text" value="AES-128"/>
IKE Integrity Algorithm	<input type="text" value="SHA-1"/>
Diffie-Hellman Group	<input type="text" value="Group14(2048bits)"/>
IKE Life Time	<input type="text" value="28800"/>
Authentication Type	<input type="text" value="Pre-shared Key"/>
Pre-shared Key	<input type="text" value="123456abc"/>

Local Identifier	<input type="text"/>
Peer Identifier	<input type="text"/>
ESP Encryption Algorithm	AES-128 <input type="button" value="v"/>
ESP Integrity Algorithm	SHA-1 <input type="button" value="v"/>
DPD Timeout	<input type="text" value="60"/> <input type="button" value="s"/> seconds
DPD Detection Period	<input type="text" value="60"/> <input type="button" value="s"/> seconds
DPD Action	Restart <input type="button" value="v"/>

1) Peer Address

To enter peer IP address or Domain Name, if choose as a server, you don't need to enter it.

2) Negotiation Method

You can choose 'Main' or 'Aggressive'.

3) Tunnel Type

You can choose 'Site to Site', 'Site to Host', 'Host to Host', 'Host to Site'.

4) Local Subnet

Local subnet and mask, like 192.168.10.0/24.

5) Peer Subnet

Peer subnet and mask, like 192.168.20.0/24.

6) IKE Encryption Algorithm

IKE phase encryption method

7) IKE Lifetime

To set up IKE lifetime.

8) Local Identifier

Local identifier of channel, can be an IP address or domain name.

9) Peer Identifier

Peer identifier of channel, can be an IP address or domain name.

10) ESP Encryption Algorithm

The encryption method of ESP.

3.5 Advanced

You can set up some advanced functions here.

3.5.1 Static Routing

Static routing is used to add a routing table entry.

Interface	Target	IPv4-Netmask	IPv4-Gateway	Metric	
	Host-IP or Network	if target is a network			
lan	<input type="text"/>	255.255.255.2	<input type="text"/>	0	<input type="button" value="Delete"/>

Interface: To choose which interface you want to add routing.

Target: Can be a host IP, or subnet.

IPv4 Netmask: The netmask of subnet, if the target is host, the netmask shall be 255.255.255.255.

IPv4 Gateway: The address of next-hop gateway address.

Note: this address shall be achievable, or you'll fail to add static routing.

3.5.2 Net Flow

The traffic meter function of TG465 is for traffic statistics from WAN port, meanwhile, it has traffic overflow alarm function. Even if the router is powered off, the traffic statistics will be saved, and when you power on the router, the traffic will be counted based on your last time traffic.

- > [View](#)
- > [Setup](#)
- > [Secure](#)
- > [VPN](#)
- > [Advanced](#)
 - Static Routes
 - [Net Flow](#)
 - GPS Location
 - DHCP and DNS
- > [Data Collect](#)
- > [Administrate](#)
- [Logout](#)

Net Flow

Traffic Meter

Current Day Flow	Current Month Flow
0.0G	0.0G

Net Flow

Net Flow Enable Disable

Limit Enabled

Day Limit

Month Limit

Clear Day Flow

Clear Month Flow

3.5.3 GPS Location

GPS location will report GPRMV information regularly, saying longitude and latitude information. And this function is used for accurate location of outdoor open area.

- > View
- > Setup
- > Secure
- > VPN
- > **Advanced**
 - Static Routes
 - Net Flow
 - GPS Location
 - DHCP and DNS
- > Data Collect
- > Administrate
- Logout

GPS Location

GPS Location Enable Disable

GPS Source External Dongle

Output Mode ▾

Server Address

Server Port

Report Mode ▾

User Defined Register Packet ⓘ Max 128 Bytes ASCII

User Defined Heartbeat Packet ⓘ Max 128 Bytes ASCII

Report Interval ⓘ Seconds

Heartbeat Interval ⓘ Seconds

GPS Info

Connection Status -

Server Address: The IP address of server that you want the router to report the location, which is based on TCP connection.

Server Port: The port of server.

Report Interval: The interval time for auto report of router location, default value is 60 seconds.

3.5.4 DHCP and DNS

General DHCP and DNS settings base on “dnsmasq” tool on TG465. Please refer to “dnsmasq” for more information.

3.6 Data Collect

Data Collect settings is for TG465 acquiring data from slave devices in serial ports, Ethernet ports, IO ports, with Modbus protocol and other customized protocols. Also support customize data display on LCD (only for TG462S).

3.6.1 Basic Setting

Enable or Disable the data collect feature, setting the data acquire and report period and other related options.

- > View
- > Setup
- > Secure
- > VPN
- > Advanced
- > Data Collect
 - Basic Setting
 - Interface Setting
 - Modbus Rules Setting
 - IO Setting
 - Server Setting
 - Data View Setting
- > Administrate
- Logout

Basic Setting

Data Collect Enable Disable

Collect Period Seconds

Report Period Seconds

Enable Cache Cache History Data

Cache Days day

Cache Path Path Where Data Is Stored

Send Minute Data

Send Hour Data

Send Day Data

- 1) Data Collect: Enable or Disable data collect feature.
- 2) Collect Period: Set the period of data acquire from slave devices.
- 3) Report Period: Set the Period of data report to server.
- 4) Enable Cache: Enable or Disable history data cache feature.
- 5) Related data cache setting if enable the cache feature.

3.6.2 Interface Setting

Serial Ports&TCP Ports:

Switch the hardware interfaces for data acquisition from kinds of slave devices. Including Serial ports (COM1~COM2), Modbus TCP base on Ethernet LAN.

- > View
- > Setup
- > Secure
- > VPN
- > Advanced
- > Data Collect
 - Basic Setting
 - Interface Setting
 - Modbus Rules Setting
 - Server Setting
 - Data query
- > Administrate
- > Debug
- Logout

Interface Setting

COM1/RS485

COM2/RS485

Enabled Enable Disable

Baudrate

Databit

Stopbit

Parity

Frame Interval ms

COM Protocol

Command Interval ms

TCP Server Setting

TCP Server1 TCP Server2 TCP Server3 TCP Server4 TCP Server5

Enabled Enable Disable

Server Address

Server Port

Frame Interval ms

COM Protocol

Command Interval ms

Connection Status

GPS Device: GPS location data can be reported to different kinds of servers, such as TCP and MQTT, if you would like to send GPS data to MQTT, need enable GPS function at Page Advanced/GPS Location First. Factor Name will be the Longitude and Latitude, separate by semicolon and set the number of Reporting Center.

GPS Device

Must Enable GPS On Page Advanced/GPS Location First

GPS Enable Disable

Factor Name Longitude and Latitude

Alias Name

Reporting Center eg: 1-2-3-4-5

3.6.3 Modbus Rules Setting

Modbus Rules Setting is for TG465 as a Modbus master to acquire data from slave devices base on Modbus protocol. You can configure unlimited Modbus rules on it. TG465 provide the options of definable factor name, device ID, function code, register address and count register number, please following the slave device datasheet to get those information.

- > View
- > Setup
- > Secure
- > VPN
- > Advanced
- > Data Collect
 - Basic Setting
 - Interface Setting
 - Modbus Rules Setting
 - IO Setting
 - Server Setting
 - Data View Setting
- > Administrate
- Logout

Modbus Rules Setting

Modbus Rules

Order	Device Name	Interface	Factor Name	Device ID	Function Code	Start Address	Count	Data Type	Reporting Center	Enable	
1	T&HSensor1	COM5	temperature; humidity	1	4	1	2	unsigned 16Bits AB	1	<input checked="" type="checkbox"/>	Edit Delete

New Modbus Rule

Order	Device Name	Interface	Factor Name	Device ID	Function Code	Start Address	Count	Data Type	Reporting Center	
<input type="text"/>	<input type="text"/>	COM5	<input type="text"/>	<input type="text" value="0-255"/>	<input type="text" value="0-255"/>	<input type="text" value="0-65535"/>	<input type="text" value="1-120"/>	Unsigned 16Bits	<input type="text" value="1-2-3-4-5"/>	Add

[Save & Apply](#)
[Save](#)
[Reset](#)

- > View
- > Setup
- > Secure
- > VPN
- > Advanced
- > Data Collect
 - Basic Setting
 - Interface Setting
 - Modbus Rules Setting
 - IO Setting
 - Server Setting
 - Data View Setting
- > Administrate
- Logout

Modbus Rules - T&HSensor1 - COM5

enabled [Disable](#)

Order:

Device Name:

Belonged Interface:

Factor Name: Multiple Factors Are Separated By Semicolor

Alias Name: Multiple Aliases Are Separated By Semicolor

Device ID: 0-255

Function Code: 0-255

Start Address: 0-65535

Count: 1-120

Data Type: A highest byte

Reporting Center: Multiple Servers Are Separated By Minus

Unit: Multiple Units Are Separated By Semicolon

Operator: 0 + - * /

Operand:

Accuracy: 0-6

3.6.4 IO Setting

IO Setting menu is for setting ADC ports, DI ports, and Relay ports.

1) ADC ports setting

IO Setting

ADC Setting

Device Name	ADC Channel	Factor Name	Capture Type	Range Down	Range Up	Reporting Center	Accuracy	Enable	
WL_Sensor	ADC1	WaterLevel	4-20mA	0	20	1	1	<input checked="" type="checkbox"/>	Edit Delete

New ADC Channel:

Device Name	ADC Channel	Factor Name	Capture Type	Range Down	Range Up	Reporting Center	Accuracy	
<input type="text"/>	ADC1	<input type="text"/>	4-20mA	<input type="text"/>	<input type="text"/>	1-2-3-4-5	0	Add

ADC Setting - ADC1 - WaterLevel

enabled [Disable](#)

Device Name

ADC Channel

Factor Name

Alias Name

Capture Type

Range Down

Range Up

Reporting Center Multiple Servers Are Separated By Minus

Accuracy 0-6

Unit

Operator

Operand

[Back to Overview](#)

2) DI ports setting

DI Setting

Device Name	DI Channel	Factor Name	Mode	Reporting Center	Count Method	Debounce Interval	Enable	
DoorSensor	DI1	doorstate	Status Mode	1	Rising Edge	2	<input checked="" type="checkbox"/>	Edit Delete

New DI Channel:

Device Name	DI Channel	Factor Name	Mode	Reporting Center	Count Method	Debounce Interval	
<input type="text"/>	DI1	<input type="text"/>	Counting	1-2-3-4-5	Rising Ed	<input type="text"/>	Add

DI Setting - DI1 - doorstate

enabled [Disable](#)

Device Name

DI Channel

Factor Name

Alias Name

Mode

Reporting Center Multiple Servers Are Separated By Minus

Unit

[Back to Overview](#)

[Save & Apply](#)

[Save](#)

[Reset](#)

3) Relay Setting

Relay Setting

Device Name	Relay Channel	Factor Name	Reporting Center	Relay Control	Enable	
motor1	Relay1	motor	1	Open	<input checked="" type="checkbox"/>	Edit Delete

New Relay Channel:

Device Name	Relay Channel	Factor Name	Reporting Center	Relay Control	
<input type="text"/>	Relay1	<input type="text"/>	1-2-3-4-5	Open	Add

Relay Setting - Relay1 - motor

enabled

Device Name

Relay Channel

Factor Name

Alias Name

Reporting Center ? Multiple Servers Are Separated By Minus

Relay Control

[Back to Overview](#)

[Save](#)

3.6.5 Server Setting

Server setting menu allows user set the data center address with multiple protocols, the standard TG465 support TCP, UDP, HTTP, MQTT, and Modbus TCP. For the data format, TG465 support different Encapsulation type, include "Transparent", "JSON", and "HJ212" (special for some Environment SCADA). Also TG465 accept customize specific protocols for your data center.

- > View
- > Setup
- > Secure
- > VPN
- > Advanced
- ✓ Data Collect
 - Basic Setting
 - Interface Setting
 - Modbus Rules Setting
 - IO Setting
 - Server Setting
 - Data View Setting
- > Administrate
- Logout

Server Setting

Server1 Settings
Server2 Settings
Server3 Settings
Server4 Settings
Server5 Settings

Enabled Enable Disable

Protocol

Encapsulation Type

Server Address

Server Port

User Defined Register Packet ⓘ Max 128 Bytes

Use HEX Format ⓘ Default is ASCII

User Defined Heartbeat Packet ⓘ Max 128 Bytes

Use HEX Format ⓘ Default is ASCII

Heartbeat Interval ⓘ Seconds, 0 means No Heartbeat

Enable Self Defined Variable

Connection Status **CONNECTED**

3.7 Administrate

3.7.1 System

Hostname

Timezone

Language

Enable telnet access Enable Disable

Enable SSH access Enable Disable

1) Host Name

The host name of router, default name is router.

2) Time Zone

Set up the time zone of system, default time zone is GMT8.

3) Language

Change the language of configuration interface, default language is English.

4) Enable Telnet Access

To enable the telnet server, the default function is enable.

5) Enable SSH Access

To enable the SSH server, the default function is disable.

3.7.2 Password

To revise the password of router.

Origin Password	<input type="text"/>	
Password	<input type="text"/>	
Confirmation	<input type="text"/>	

1) Origin Password

You'll be required to enter your origin password before your revise your new password.

2) Password

Type the new password you want to change.

3) Confirmation

Type the new password again to confirm it.

If the new password and confirmation password you type is different, then it fails to revise the password. After password revised, router will return to login page, then you can enter your username and password.

3.7.3 Time Setting

System time type includes RTC (Real Time Clock) and NTP (Network Time Protocol). RTC will save time even router is powered off, while for NTP, router will connect to NTP server which requires internet connection, time won't be saved once powered off. But NTP will be more accurate than RTC, and you may need to adjust the time manual if it is not accurate.

Set System Time

Current system time 2020-07-17 15:19:39

System Time Type ntp rtc

Current RTC Time

RTC Date eg: 2016-01-01

RTC Time eg: 12:00:00

Save & Apply Save Reset

1) Current System Time

Display the time of router.

2) System Time Type

It includes NTP and RTC mentioned above, and different type has different configuration parameters

● RTC

You can update data and time yourself.

RTC Date eg: 2016-01-01

RTC Time eg: 12:00:00

RTC Data

Format must be: 20xx-xx-xx (Year-Month-Day), or you will fail to update it.

RTC Time

Format must be xx: xx: xx (Hour-Min-Second), or you will fail to update it.

- **NTP**

NTP Time Server	<input type="text" value="0.openwrt.pool.ntp.org"/>
Port	<input type="text" value="123"/>
Update Interval	<input type="text" value="600"/> seconds

NTP Time Server

You can select the NTP time server through drop-down menu, or you can customize it yourself.

Port

NTP time server port, default port is 123.

Update Interval

How long to sync the time with NTP server, default time is 600 seconds.

3.7.4 Log Settings

Log settings is for configuring the output parameters of system log.

Output To Device	<input type="text" value="/var/log/"/>
Log Size	<input type="text" value="64"/> KB
Log Server	<input type="text" value="0.0.0.0"/>
Log Server Port	<input type="text" value="514"/>
Output Level	<input type="text" value="Debug"/>

1) Output to Device

You can output the log to serial port, or specified file path, or external storage device, and the default path is:/var/log/

2) Log Size

Set up the size of log, default value is 64KB.

3) Log Server

Set up the IP address of log server.

4) Log Server Port

Set up the port of log server, default value is 514

5) Output Level

There are several levels supported, including 'Debug', 'Info', 'Notice', 'Warning', 'Error', and level increased in sequence, the higher level, the less output log.

3.7.5 Backup and Reset

User can either backup the configuration of router, or reset to factory defaults.

Backup / Restore

Click "Generate archive" to download a tar archive of the current configuration files. To reset the firmware to its initial state, click "Perform reset" (only possible with squashfs images).

Download backup:

Reset to defaults:

To restore configuration files, you can upload a previously generated backup archive here.

Restore backup:

1) Download Backup

Click to generate a configuration file in format of "backup-router-2016-**-**.tar.gz".

2) Reset to Default

Click 'Perform Reset', and a pop-up confirmation box with 'Really Reset All Changes' will display, then click 'OK' to reset to factory defaults.

3) Restore Backup

To restore configuration files, you can upload a previously generated backup archive here.

Restore backup:

After reset to default, you can also upload the saved configuration file to router, to recover

the previous configuration. Click 'upload archive', select and upload the backup configuration file, and a pop-up confirmation box with 'Really Restore' will display, then click 'OK', to recover the configuration.

3.7.6 Firmware Upgrade

Before you upgrade the firmware for router, make sure the firmware you're planning to upload is correct. If errors occurs, use serial port and connect the Ethernet cable, upgrade the firmware through u-boot.

Flash new firmware image

Upload a sysupgrade-compatible image here to replace the running firmware. Check "Keep settings" to retain the current configuration (requires an OpenWrt compatible firmware image).

Keep settings:

Image:

1) Keep Settings

Click it, and system configuration will not be changed after firmware upgrade.

2) Choose and Upload Firmware Image

Click 'browse' and select the firmware, then click 'Flash Image', and firmware will be upload to router. Then you'll go to below page.

Flash Firmware - Verify

The flash image was uploaded. Below is the checksum and file size listed, compare them with the original file to ensure data integrity.

Click "Proceed" below to start the flash procedure.

Checksum: `#68983dbe5ec7f0d4bf9258e421ad53d`

Size: 9.00 MB

Configuration files will be kept.

- **Checksum**

MD5 checksum value of firmware.

- **Size**

The size of firmware.

- **Proceed**

Click 'proceed' to start the firmware upgrade, or click 'cancel' to stop the firmware upgrade.

3.7.7 Remote Management

Remote Management feature allows TG465 **work with Bivocom Device Management Platform** for remote management, like firmware upgrade, configuration change, etc.

You can configure the IP address and port of remote DMP server, device number and phone number of router, etc., as below.

Remote Manage Enable Disable

Server Address

Server Port

Heart Interval

Device Number

Device Phone Number

Device Type

1) Remote Manage

You can enable or disable this function to choose if you want to remote manage the router or not.

2) Server Address

Type the specified login server address you want to remote manage the router, it can be either an IP address or Domain Name.

3) Server Port

The specified login server port.

4) Heartbeat Interval

The heartbeat time interval (Unit: second)

5) Device Number

Device ID of router.

6) Device Phone Number

The phone number of SIM card insert in router.

7) Device Type

Type of the device, default is router.

You can also remote upgrade the firmware for router, as below.

Remote Upgrade Enable Disable

Server Address

Server Port

Firmware Version

8) Remote Upgrade

Click 'Enable' to enable remote firmware upgrade function.

9) Server Address

Type the server IP address or Domain Name for remote upgrade.

10) Server Port

Type the server port for remote upgrade.

11) Firmware Version

Type the firmware version that you want to upgrade remotely.

3.7.8 Manual Reboot

Reboots the operating system of your device



Click 'Perform Reboot', and a pop-up confirmation box with 'Really Reboot' will display, then click 'OK' to reboot the router.

3.7.9 Schedule Reboot

Schedule Reboot allows user configure the period or dedicate time for device reboot.

Schedule Reboot

Enable Schedule Reboot Enable Disable

Schedule Type By Period By Time

Period Interval  Minutes, Min 5