

# Bivocom<sup>®</sup>

## Industrial Cellular WIFI Router TR341 Series User Guide

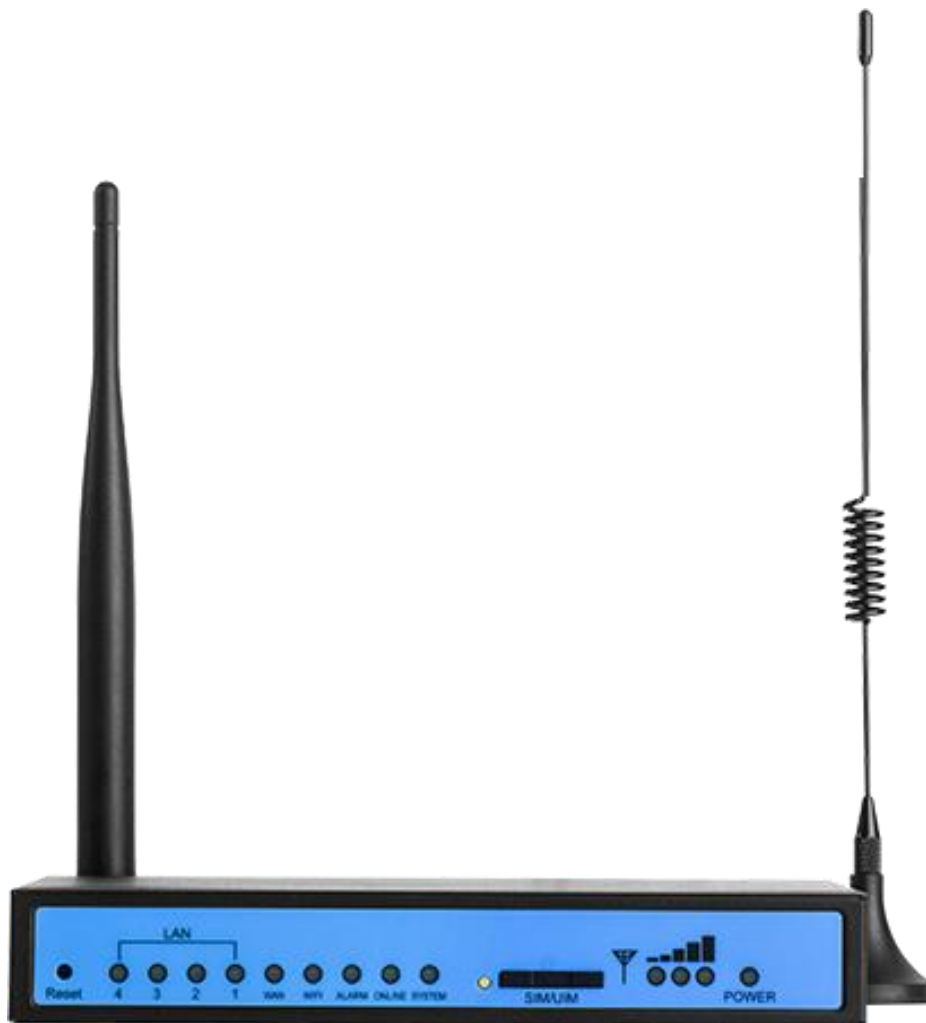

## Copyright

Copyright © XIAMEN BIVOCOM TECHNOLOGIES CO., LTD. All rights reserved.

## Trademark

BIVOCOM logo is a registered trademark of Xiamen Bivocom Technologies Co., Ltd. All other trademarks belong to their respective vendors or manufactures.

## Disclaimer

Product specifications and information in this document are subject to change without any notice, and BIVOCOM reserves the right to improve and change this user guide at any time. Users should take full responsibility for their application of products, and Xiamen Bivocom Technologies Co., Ltd. disclaims all warranties and liability for the accurateness, completeness of the information published.

## Global Technical & Sales Support

# Bivocom

**Xiamen Bivocom Technologies Co., Ltd.**

Addr: Unit 1402, No. C07 Building, 3<sup>rd</sup> Software Park, Xiamen, China 361000

Tel.: +86-592-6211770

Fax: +86-592-6211727

Email: [support@bivocom.com](mailto:support@bivocom.com)

[sales@bivocom.com](mailto:sales@bivocom.com)

[www.bivocom.com](http://www.bivocom.com)

## About This Guide

Thank you for choosing Bivocom Industrial Cellular Router TR341 Series.

Please thoroughly read this user guide before you configure and install the device.

This manual is compatible with below models

Model	Description
TR341-W	Industrial WCDMA ROUTER
TR341-LF	Industrial LTE/WCDMA ROUTER

# Table of Contents

Copyright .....	2
Trademark .....	2
Disclaimer.....	2
About This Guide.....	3
Table of Contents.....	4
1. Introduction .....	6
1.1 Overview .....	6
1.2 Applications.....	6
1.3 Dimensions .....	7
1.4 Physical Characteristics.....	7
2. Getting Started .....	8
2.1 Package Checklist .....	8
2.2 Installation.....	9
2.2.1 SIM/UIM Card .....	9
2.2.2 5-Pin Terminal Block and Console Cable .....	9
2.2.3 Power Supply .....	10
2.2.4 Cellular Antenna .....	10
2.2.5 WIFI Antenna .....	10
2.3 LED Indicators.....	11
2.4 Reset .....	12
3. Configuration and Management .....	12
3.0 Getting start Web UI.....	12
3.0.1 Connect your PC to TR341 network.....	12
3.0.1 Login the WebUI .....	12
3.1 View .....	13
3.1.1 System .....	13
3.1.2 Network.....	14
3.1.3 Routing Tables .....	15
3.1.4 System Log.....	16
3.1.5 VPN Status .....	16
3.2 Setup .....	17
3.2.1 WAN .....	17
3.2.2 LAN.....	19
3.2.3 Wireless .....	20
3.2.4 Wireless Client.....	22
3.2.5 Online Detection .....	23
3.2.6 Diagnostics .....	25
3.3 Security .....	25
3.3.1 DMZ Host.....	25
3.3.2 Port Forwarding .....	26

3.3.3 Traffic Rules.....	27
3.3.4 Custom Settings .....	29
3.4 VPN.....	29
3.4.1 PPTP .....	29
3.4.2 L2TP .....	31
3.4.3 OpenVPN.....	35
3.4.4 IPSec.....	36
3.4.5 GRE .....	38
3.5 Advanced .....	38
3.5.1 Send SMS.....	38
3.5.2 Static Routing.....	39
3.5.3 Net Flow.....	39
3.5.4 GPS Location .....	40
3.5.5 BS Location (Option).....	40
3.5.6 Dynamic DNS.....	41
3.5.7 DHCP and DNS .....	43
3.6 Data Collect .....	44
3.6.1 Basic Setting .....	45
3.6.2 Interface Setting.....	45
3.6.3 Modbus Rules Setting.....	46
3.6.4 Server Setting .....	47
3.7 Administrate .....	48
3.7.1 System .....	48
3.7.2 Password .....	49
3.7.3 Time Setting .....	49
3.7.4 Log Settings .....	51
3.7.5 Backup and Reset .....	52
3.7.6 Firmware Upgrade.....	52
3.7.7 Remote Management .....	53
3.7.8 Manual Reboot.....	55
3.7.9 Schedule Reboot.....	55
3.8 Logout.....	55

# 1. Introduction

## 1.1 Overview

TR341 Series Router is a type of industrial 802.11/b/g/n wireless router, designed to fully meet the needs of industrial standards and industrial users. It adopts high-powered industrial 32-bits CPU, multi-layer software detection and hardware protection mechanism to ensure reliability and stability of the device. It supports worldwide carrier 4G/3G cellular network FDD-LTE, TD-LTE, and WCDMA, EVDO, TD-SCDMA, EDGE, CDMA 1X and GPRS. With rich VPN protocols(IPSEC、PPTP、L2TP etc.) to ensure the security of data transmission.

TR341 Series Router enables users to quickly access the Internet, to ensure secure and reliable data transmission. It's ideal for IOT (Internet of Things) and M2M(Machine to Machine) applications, and has been widely used in many applications, such as Intelligent Transportation, Smart Grid, Vending Machine, Agricultural Irrigation, Environmental Protection, Industrial Automation, Energy Saving, Smart Home, etc.

## 1.2 Applications

TR341 Series Router utilizes cellular network to connect your network devices and serial port devices to your center for remote monitoring and control.

Typical application as below.

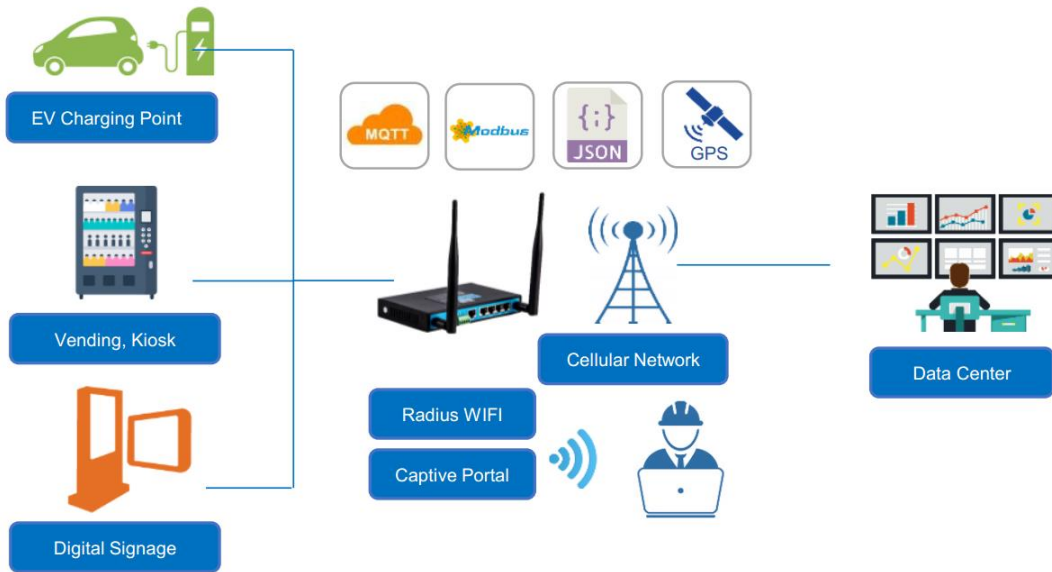

## 1.3 Dimensions

Dimensions(mm)

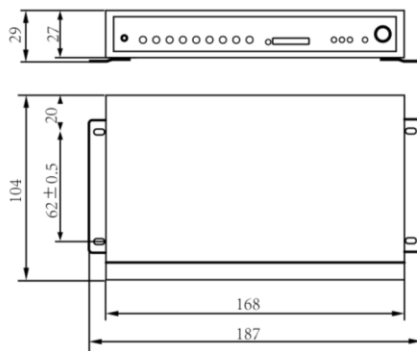

Side Views

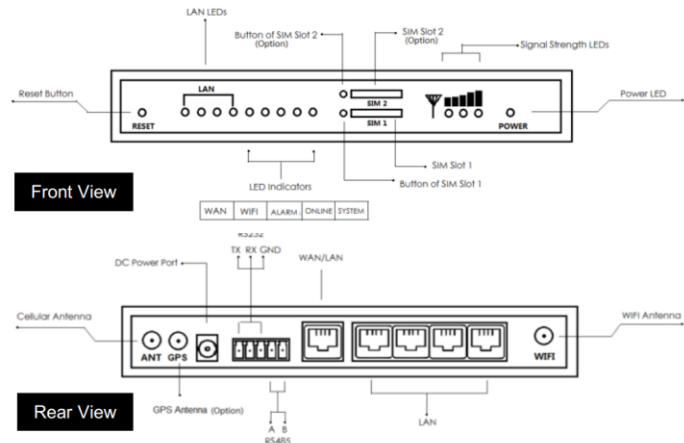

## 1.4 Physical Characteristics

Physical Characteristics	
Housing	Metal, IP30
Dimensions	168 x 104 x 27mm (6.61 x 4.09 x 1.06 in), Antenna and other accessories not included
Weight	530 g(1.17lbs)

## 2. Getting Started

### 2.1 Package Checklist

The following components are included in your TR341 package.

Check the list before installation. If you find anything missing, Please feel free to contact Bivocom.

- TR341 Router Host
- Power Adapter(DC 12V/1.5A)
- WIFI Antenna(Female SMA)
- Cellular Antenna (Male SMA)
- Console Cable(RS232)
- Ethernet Cable(1 meter)
- 5-Pin Terminal Block

Ethernet Cable



RS232 Cable



Power Adapter



TR341 Host



WIFI Antenna



Cellular Antenna



5-Pin Terminal Block



## 2.2 Installation



### 2.2.1 SIM/UIM Card

TR341 supports normal SIM/UIM only, so if you're using a Micro SIM or Nano SIM card, you may need to use a Micro SIM or Nano SIM to Normal SIM adapter.

Make sure your router is powered off, then use a needle object (such as a pen) to push the button near the SIM/UIM card holder, it will flick out immediately. Put the SIM/UIM card to card holder with chipset upside, insert it to router and make sure it's tightly matched.

Warning: Never install SIM/UIM card when router is powered on.

### 2.2.2 5-Pin Terminal Block and Console Cable

TR341 supports RS232 and RS485 serial port, which can be used for firmware upgrade, system log checking, or acts as serial port of a DTU (Please refer to Bivocom TD210 Series DTU).

TR341 designed with industrial terminal block interface, and the cable in this package with ends of female connector and stripping cable, the signal of console cable is defined as below,

#### **RS232 Cable(with DB9 female connector and stripping cable)**

Color of cable	Corresponding DB9-Female Pin No.	Corresponding Pin No. of Router (Pin 1 closes to power jack, Pin 5 closes to ethernet port)
Blue	2 (RX)	1(TX)
Brown	3 (TX)	2(RX)
Black	5 (GND)	3(GND)

#### **RS485 Cable**

Color of cable	TR341 Router
Red	4(A)
Black	5(B)

### **2.2.3 Power Supply**

We suggest you use Bivocom standard power adapter (1.5A/12VDC). If you have to use your own power supply, make sure the power range is 5-35VDC and it is stable enough(Ripple shall be less than 300mV, and Instantaneous voltage shall not larger than 35V), meanwhile, power shall over 4W.

### **2.2.4 Cellular Antenna**

Screw the SMA male antenna to TR341(SMA female port), make sure it is screwed tightly to ensure the strength of signal.

### **2.2.5 WIFI Antenna**

Screw the SMA female WIFI antenna to TR341(SMA male port), make sure it is screwed tightly to ensure the strength of signal.

## 2.3 LED Indicators



TR341 Series Router provides 7 LED indicators, as following.

Indicator	Status	Content
Power	On	Powered On
	Off	Powered Off
Signal Strength	1 Lights	Signal weak
	2 Lights	Signal Middium
	3 Lights	Signal Strong
System	Blink	System works perfect
	Off	System doesn't work
Online	On	Router accesses to Internet
	Off	Router doesn't access to Internet
Alarm	On	<ul style="list-style-type: none"> <li>● SIM/UIM Card is not insert corectly or broken</li> <li>● Antenna signal is too weak</li> </ul>
	1 Blink Per Second	Cellular module was not registered to router
	2 Blinks Per Second	Router can't access to Internet
	Off	Router doesn't have any alarm
WAN	On	WAN is connected
	Off	WAN is not connected
LAN	Blink	LAN works
	Off	LAN is not connected

## 2.4 Reset

You can press the Reset button to reset settings to factory defaults to solve the problem of incorrect configuration that makes you couldn't access to internet, login and management, etc.

Use a needle object(such as pen) to insert into hole of 'Reset', hold until all the LED indicators turn off.

## 3. Configuration and Management

### 3.0 Getting start Web UI

TR341 provide visible and easy-to-use WebUI for configuration setting and management. Below sections indicate each menu items feature introduce and setting on WebUI.

#### 3.0.1 Connect your PC to TR341 network.

- Using an Ethernet cable, connect one end of the Ethernet cable to the LAN port on TR341 unit and the other end to a LAN port on a PC.
- Or use your laptop to connect to WIFI hotspot 'Bivocom\_XXXX' from TR341, login with default password: "admin123".
- If your PC is configured to automatically get an IP address, it will obtain the IP address from the TR341 DHCP. Otherwise, make sure your PC can connect to the network 192.168.1.0 (255.255.255.0).

#### 3.0.1 Login the WebUI

Enter 192.168.1.1 into the address bar of your PC web browser. Login with user name and password both "admin" as default. A web page with menu items will guide you start the configuration.

The screenshot shows the web interface of a Bivocom TR341 Industrial Cellular Router. The browser address bar shows the URL 192.168.1.1/cgi-bin/luci. The page header includes the Bivocom logo, the tagline "Leading Wireless Solution Provider", and the slogan "For The Internet Of Things". The model name "TR341" and "Industrial Cellular Router" are also displayed. A navigation menu on the left includes options like View, Setup, Secure, VPN, Advanced, Data Collect, and Administrate, along with a Logout button. The main content area is titled "Status" and is divided into two sections: "System" and "Memory".

System	
Hostname	router
Model	BIVOCOM341
SN	20201029311
Firmware Version	41.1.1.41
Release Time	2020-11-05 10:35:12
Local Time	2021-03-22 10:51:37 Monday
Uptime	0h 9m 42s
Load Average	0.15, 0.11, 0.08

Memory	
Total Available	104060 kB / 124320 kB (83%)

## 3.1 View

View page shows the basic system information including System, Network, Routes, System Log, VPN Status. Checking the following details information.

### 3.1.1 System

System page show you an overview of TR341 information like SN, Firmware version, Memory usage, etc.

## Status

### System

Hostname	router
Model	BIVOCOM341
SN	20201029311
Firmware Version	41.1.1.41
Release Time	2020-11-05 10:35:12
Local Time	2021-03-22 10:52:46 Monday
Uptime	0h 10m 52s
Load Average	0.15, 0.11, 0.08

### Memory

Total Available	104048 kB / 124320 kB (83%)
Free	86348 kB / 124320 kB (69%)
Cached	13528 kB / 124320 kB (10%)
Buffered	4172 kB / 124320 kB (3%)

### 3.1.2 Network



Network page display the current WAN status, like network type, IP address, Connect Status, and so on. Also indicate the LAN Status, Wireless Status, DHCP Leases.

- ✓ **View**
- System
- Network**
- Routes
- System Log
- VPN Status
- > **Setup**
- > **Secure**
- > **VPN**
- > **Advanced**
- > **Data Collect**
- > **Administratrate**
- Logout

## Status

### Network

IPv4 WAN Status

 **Type:** lte  
**Address:** [10.191.11.21](#)  
**Netmask:** 255.255.255.252  
**Gateway:** [10.191.11.22](#)  
**Mac Address:** 22:60:1d:d3:83:0a  
**DNS 1:** [202.103.44.150](#)  
**DNS 2:** [202.103.24.68](#)  
**Connected:** 6h 37m 4s  
 **Signal:** 26 (-61 dBm)  
**Network:** LTE  
**SIM Status:** ON  
**IMEI:** 357621093350256  
**ICCID:** 89860320960275206273  
**Connect Status:** CONNECTED

Online Status online

Active Connections 35 / 16384 (0%)

### LAN Status

IP Address 192.168.1.1  

---

 Netmask [255.255.255.0](#)  

---

 DHCP Server Enable  

---

 Mac Address 00:52:24:34:2f:4f

### 3.1.3 Routing Tables

Display ARP list and active routing tables.

- View
  - System
  - Network
  - Routes
  - System Log
  - VPN Status
- Setup
- Secure
- VPN
- Advanced
- Data Collect
- Administrate
- Logout

## Routes

The following rules are currently active on this system.

### ARP

IPv4-Address	MAC-Address	Interface
192.168.1.244	4c:34:88:87:e3:a8	br-lan
192.168.1.10	00:00:00:00:00:00	br-lan

### Active IPv4-Routes

Network	Target	IPv4-Gateway	Metric
wan	<a href="#">10.191.11.20/30</a>	0.0.0.0	0
lan	192.168.1.0/24	0.0.0.0	0
wan	0.0.0.0/0	<a href="#">10.191.11.22</a>	0

### Active IPv6-Routes

Network	Target	IPv6-Gateway	Metric
loopback	0:0:0:0:0:0:0:0	0:0:0:0:0:0:0:0	FFFFFFF

## 3.1.4 System Log

System log page continuous print the current running status syslog. It is useful for troubleshooting when there are some features working not as expected. System log page provide three buttons for “Clear Log” which empty current printed log, “Save Log” which saving current printed log as a file, and “Refresh Log” which asking print out latest log.

- View
  - System
  - Network
  - Routes
  - System Log
  - VPN Status
- Setup
- Secure
- VPN
- Advanced
- Data Collect
- Administrate
- Logout

## System Log

Clear Log
Save Log
Refresh Log

```

Mar 16 18:14:46 diald[1297]: AT+CGPADDR*M
Mar 16 18:14:46 diald[1297]: ^M +CGPADDR: 1,10.191.11.21^M +CGPADDR: 2,0.0.0.0,0.0.0.0,0.0.0.0,0.0.0.0,0.0.0.0^M +CGPADDR: 3,0.0.0.0^M +CGP
Mar 16 18:14:46 diald[1297]: address is 10.191.11.21
Mar 16 18:14:56 dctd[2981]: Server Address is: 192.168.1.10
Mar 16 18:14:59 dctd[2981]: Failed to connect server 192.168.1.10, port 9001, wait 20s and retry
Mar 16 18:15:00 dctd[2981]: Start to collect data
Mar 16 18:15:00 dctd[2981]: get di data
Mar 16 18:15:00 dctd[2981]: get relay data
Mar 16 18:15:00 dctd[2981]: Start to send collected data [1]
Mar 16 18:15:01 diald[1297]: AT+PSRAT*M
Mar 16 18:15:02 diald[1297]: ^M +PSRAT: "CDMA"*M      "FDD LTE"*M ^M OK^M
Mar 16 18:15:02 diald[1297]: AT+COPS?^M
Mar 16 18:15:02 diald[1297]: ^M +COPS: 0,0,"CHN-CT",7^M ^M OK^M
Mar 16 18:15:02 diald[1297]: AT+CSQ^M
Mar 16 18:15:02 diald[1297]: ^M +CSQ: 26,99^M ^M OK^M
Mar 16 18:15:02 diald[1297]: AT$QCRMCALL?^M
Mar 16 18:15:03 diald[1297]: ^M $QCRMCALL: 1, V4^M ^M OK^M
Mar 16 18:15:03 diald[1297]: AT+CGPADDR*M
Mar 16 18:15:03 diald[1297]: ^M +CGPADDR: 1,10.191.11.21^M +CGPADDR: 2,0.0.0.0,0.0.0.0,0.0.0.0,0.0.0.0,0.0.0.0^M +CGPADDR: 3,0.0.0.0^M +CGP
Mar 16 18:15:03 diald[1297]: address is 10.191.11.21
          
```

## 3.1.5 VPN Status

Display current VPN status. If you have setup a VPN connection, there will indicate the status, like VPN type, IP address, Connected Time, etc.



- ✓ **View**
- System
- Network
- Routes
- System Log
- VPN Status
- > **Setup**
- > **Secure**
- > **VPN**
- > **Advanced**
- > **Administrative**
- Logout

## VPN

VPN Status

Type:	I2tp
IP Address:	1.32.1.3
Netmask:	255.255.255.255
Gateway:	1.32.1.1
Connected Time:	9m,32s

## 3.2 Setup

Setup page includes WAN, LAN, Wireless, Wireless Client, Online Detection, Diagnostics menus, which is for you configuring the features accordingly.

### 3.2.1 WAN

WAN Setting contains General Setup which provide configuration option for setting "Connection Type" and relevant items. It supports "Static IP", "DHCP", "PPPoE", "3G", "LTE", "Unmanaged" connection types. While the default type is LTE.

- "Static IP" is for TR341 setting static IP address to connect to upper network via WAN port.
- "DHCP" is for TR341 obtain network from Upper DHCP device (like router) via WAN port.
- "PPPoE" is for getting network via PPPoE protocol, normally you will get username password from carrier when you purchase a network.
- "3G" is for dialing up 3G or NBIOT cellular network when using a 3G SIM card or a NBIOT SIM card. You may need input APN, PIN, PAC/CHAP Username Password if your SIM card provider request.
- "LTE" is for dialing up 4G/LTE cellular network when using a 4G SIM card. You may need input APN, PIN, PAC/CHAP Username Password if your SIM card provider request.
- "Unmanaged" is for disabling WAN connection.

- > **View**
- ✓ **Setup**
  - WAN
  - LAN
  - Wireless
  - Wireless Client
  - Online Detection
  - Diagnostics
- > **Secure**
- > **VPN**
- > **Advanced**
- > **Data Collect**
- > **Administrate**
- Logout

## WAN Setting

On this page, you can configure WAN port connection type

### WAN Interface

General Settings

Advanced Settings

Connection Type

Network Type

APN

PIN

User Name

Password

Authentication Type  None  PAP  CHAP  PAP/CHAP

Note,

- 1) PAP/CHAP Username password Only when you are using a private network SIM card, if you're using public network SIM card, just keep it as null.
- 2) Choose Dial Number when you are using 3G type, different carriers may have different dial number, please ask your carrier for this info if you have questions.

### 3) WAN Used As LAN

When using LTE/3G connection type to access internet, which mean WAN port is available for you change it as a LAN port.

"Advanced Settings" menu provide this option

## WAN Setting

On this page, you can configure WAN port connection type

### WAN Interface

General Settings

Advanced Settings

Use Static IP Address

WAN Multiplex   Set WAN port as LAN port

### 3.2.2 LAN

Menu of LAN are mainly for configuring IP address of TR341, set the IP address range of DHCP server, or disable DHCP.

#### 1) Common Configuration

##### Common Configuration

General Setup   **Advanced Settings**

Protocol   Static address

IPv4 address   192.168.1.1

IPv4 netmask   255.255.255.0

DNS Servers   

#### IPv4 Address

To configure IP address of LAN port.

#### IPv4 Netmask

The netmask of LAN port IP address.

#### IPv4 Gateway

Specify the next-hop routing gateway.

#### DNS Server

To specific DNS server, leave it blank as default using upper network DNS.

#### Advanced Settings

Specific set Override MTU, and use gateway metric. Leave it blank as default.

## 2) DHCP Server Settings

General Setup

Ignore interface  [? Disable DHCP for this interface.](#)

Start  [? Lowest leased address as offset from the network address.](#)

Limit  [? Maximum number of leased addresses.](#)

Leasetime  [? Expiry time of leased addresses, minimum is 2 minutes \(2m\).](#)

- **Disable DHCP**

Click to disable DHCP server.

- **Start**

Assign the IP address of DHCP server. For example, 100 means IP address starts from 192.168.1.100.

- **Limit**

Assignable number of IP address, to ensure numbers of IP address of start and limit not exceed 250.

- **Lease time**

Time of assigning the IP address.

### 3.2.3 Wireless

Wireless menu is mainly for configuring the WiFi, SSID, mode, encryption, etc.

# Wireless Setting

On this page, we can configure Wireless general or advanced parameters

## Interface Configuration

General Settings

Advanced Settings

WiFi 2.4G  Enable  Disable

Network Name(SSID)

Bivocom\_2f50

Channel

auto

Mode

802.11bgn

Encryption

WPA2-PSK-AES

Key

••••••••

Hide SSID

### 1) WIFI 2.4G

Provide Enable or Disable option for the WIFI function switch.

### 2) Network Name (SSID)

WIFI network name setting.

### 3) Channel

Support 1-13 channels or auto options, default value is auto, channel can be changed automatically.

### 4) Mode

Support 802.11b, 802.11g, 802.11bg, 802.11bgn options. This may related to the maximum speed of WiFi. 802.11b up to 11Mbps, 802.11g up to 54Mbps and 802.11bgn up to 300Mbps.

## 5) Encryption

Configure the way of encryption,

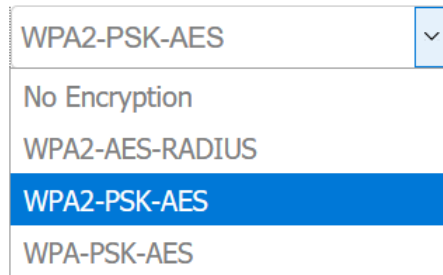

A dropdown menu showing encryption options. The current selection is 'WPA2-PSK-AES'. The menu is open, showing the following options: 'WPA2-PSK-AES' (selected), 'No Encryption', 'WPA2-AES-RADIUS', 'WPA2-PSK-AES', and 'WPA-PSK-AES'.

While for RADIS option, it provide for configuring Radis Auth Server address, shared key, etc.

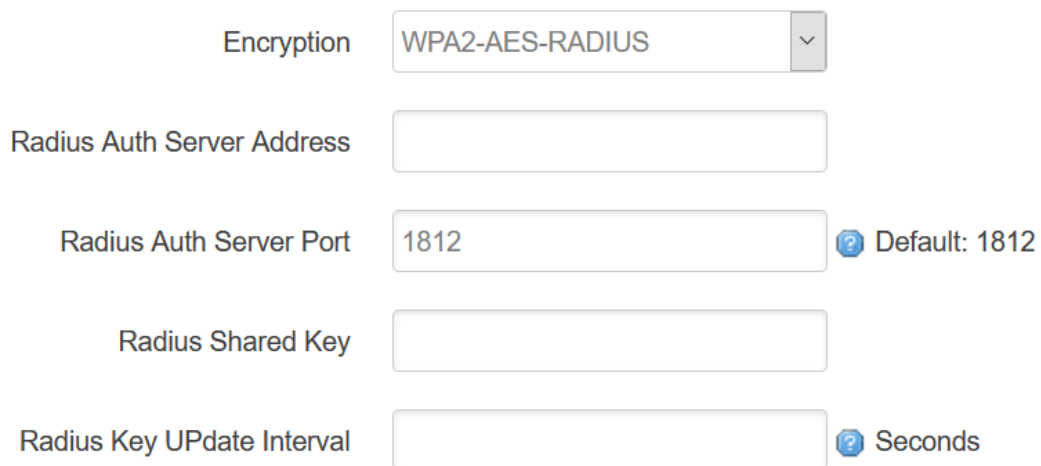

A form for configuring RADIS options. It includes the following fields:

- Encryption: WPA2-AES-RADIUS
- Radius Auth Server Address: [Empty text box]
- Radius Auth Server Port: 1812 (Default: 1812)
- Radius Shared Key: [Empty text box]
- Radius Key UPdate Interval: [Empty text box] (Seconds)

## 6) Key

Password of sharing the WIFI, user need to enter it to access the internet. The minimum length of password is 8 bytes.

## 7) Hide SSID

When Hide SSID enabled, SSID is invisible, and user need to enter the SSID to share the WIFI.

Advanced Settings related to some specific parameters setting, this is for professional users, contact Bivocom support team in case you have further questions.

### 3.2.4 Wireless Client

Wireless Client menu provide connecting network from local WiFi Hotspot, this setting

related to WAN setting when you select Static IP or DHCP connection type.

Enable wireless client and apply it, it will list all WiFi hotspots which can be detected. Join one of it, will ask you input the password if hotspot request.

> View

> Setup

- WAN
- LAN
- Wireless
  - Wireless Client
  - Online Detection
  - Diagnostics
- > Secure
- > VPN
- > Advanced
- > Data Collect
- > Administrate

Logout

**Save and Apply on page WAN after Join**

Enable 2.4G Wireless Client  Apply

Scan WiFi

Scanned WiFi

SSID	Channel	Encryption	Signal	
TOP-IOT-D	1	WPA1PSK/WPA2PSK/TKIP/AES	100	<a href="#">Join</a>
Cozy	1	WPA1PSK/WPA2PSK/TKIP/AES	100	<a href="#">Join</a>
CMCC-xrxN	1	WPA1PSK/WPA2PSK/TKIP/AES	100	<a href="#">Join</a>
3b38	3	WPA2PSK/AES	70	<a href="#">Join</a>

### 3.2.5 Online Detection

Online detection feature checking the network connection status periodically, if there has issue of connection, router will auto reconnect. If it fails to reconnect after times of trial, router will reboot automatically to try to recovery the network.

#### Online Detection

Online Detection  Enable  Disable

Detection Type

Primary Detection Server

Second Detection Server

Retry Times

Retry Interval  [?](#) Seconds

Enable Reboot  Enable  Disable

Reboot After Interval  [?](#) Minutes

## 1) Detection Type

There are 3 types: ping, traceroute and DNS.

- **Ping**

Router will ping an IP address periodically, if works, that means router is online.

- **Traceroute**

Traceroute will trace routing path, if achieves the target address, that means router is online.

- **DNS**

DNS will analytic a domain, if it works, that means router is online.

Note: the default setting is Ping, which is highly recommended, as traceroute will cost dataflow of SIM card, while DNS is faster, but as it has cache, it may shows the router is online even it is offline.

## 2) Primary Detection Server

It can be an IP address or a Domain Name.

## 3) Second Detection Server

If primary detection server fails, then router will auto switch to second detection server.

## 4) Retry Times

You can set up retry time in case detection fails.

## 5) Retry Interval

The interval time between 2 detection.

## 6) Enable Reboot

Click enable, and router will reboot within the time set if it fails to reconnect.

## 7) Reboot After Interval

You can specify the time for offline, to reboot the router.



## 3.2.6 Diagnostics

Diagnostics feature allow user check the network connection status manually.

There are 3 types of diagnostics: ping, traceroute and nslookup

Parameter of ping and traceroute can be a Domain Name or an IP address, used for checking if router is online or not. While nslookup is to analytic domain.

### Diagnostics

Network Utilities

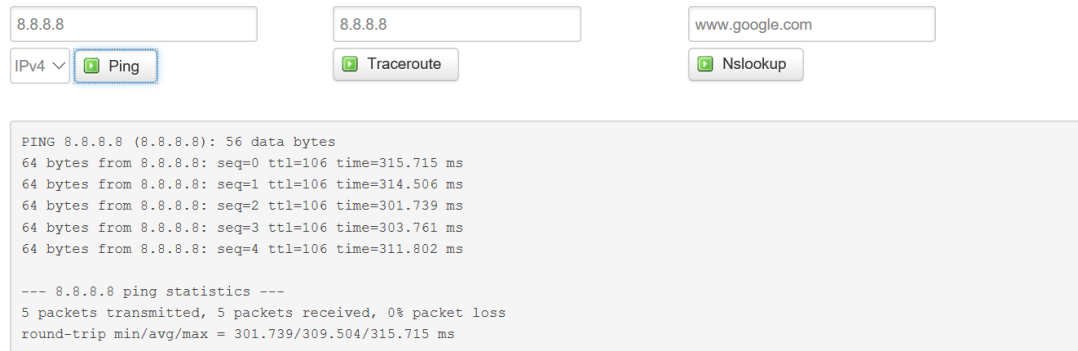

8.8.8.8      8.8.8.8      www.google.com

IPv4 ▾            

```
PING 8.8.8.8 (8.8.8.8): 56 data bytes
64 bytes from 8.8.8.8: seq=0 ttl=106 time=315.715 ms
64 bytes from 8.8.8.8: seq=1 ttl=106 time=314.506 ms
64 bytes from 8.8.8.8: seq=2 ttl=106 time=301.739 ms
64 bytes from 8.8.8.8: seq=3 ttl=106 time=303.761 ms
64 bytes from 8.8.8.8: seq=4 ttl=106 time=311.802 ms

--- 8.8.8.8 ping statistics ---
5 packets transmitted, 5 packets received, 0% packet loss
round-trip min/avg/max = 301.739/309.504/315.715 ms
```

#### 1) Ping

Click ping, then you can check if there is response from an IP address, as bellow.

#### 2) Traceroute

Click traceroute, then you can see similar reponse as below.

#### 3) Nslookup

Click nslookup, then you can see similar reponse as below.

## 3.3 Security

Menu of Security are for configuring the firewall, to ensure the security of accessing to internet, and implement the port forwarding, access control, data packet filtering, and other functions.

### 3.3.1 DMZ Host

DMZ can forward the port of WAN to a host of LAN; all packet from WAN will be forwarded to specified host of LAN. It provide select source zone from VPN or WAN if there is a VPN

connection available.

## DMZ

Set DMZ Host

DMZ  Enable  Disable

Source zone  vpn: (empty)  
 wan: wan: 

DMZ Host

### 3.3.2 Port Forwarding

Comparing with DMZ, Port Forwarding is for more precise control, user can forward the data packet of a port to a host of LAN, to forward different port to different host.

#### Firewall - Port Forwards

Port forwarding allows remote computers on the Internet to connect to a specific computer or service within the private LAN.

##### Port Forwards

Name	Match	Forward to	Enable	
myPLC	IPv4-TCP, UDP From <i>any host</i> in <i>wan</i> Via <i>any router IP</i> at port <i>501</i>	IP <i>192.168.1.244</i> , port <i>501</i> in <i>lan</i>	<input checked="" type="checkbox"/>	 Edit  Delete

##### New port forward:

Name	Protocol	External zone	External port	Internal IP address	Internal port	
<input type="text" value="New port forward"/>	TCP+UDP <input type="text"/>	wan <input type="text"/>	<input type="text"/>	<input type="text"/>	<input type="text"/>	 Add

#### 1) Name

You can name the rule you created.

#### 2) Protocol

You can choose TCP, UDP, or TCP/UDP.

#### 3) External Port

Destination port before port forwarding.

#### 4) Internal IP Address

The Host IP address to forward.

#### 5) Internal Port

The destination port after port forwarding. Normally, external port and internal port are the same, but also can be different.

After configured above-mentioned, click 'Add', then a new rule will be added, and click 'Save & Apply', to have the rule take effect. There are more setting items when click "Edit" button.



### 3.3.3 Traffic Rules

Traffic rules is used for Firewall setting like opening some ports on router, such as remote access the configuration page of router, you can open port 80.

#### Firewall - Traffic Rules

Traffic rules define policies for packets traveling between different zones, for example to reject traffic between certain hosts or to open WAN ports on the router.

##### Traffic Rules

Name	Match	Action	Enable	
enable80	Any TCP From <i>any host in wan</i> To <i>any router IP</i> at port <i>80</i> on <i>this device</i>	Accept input	<input checked="" type="checkbox"/>	 Edit  Delete

**Open ports on router:**

Name	Protocol	External zone	External port	
<input type="text" value="New input rule"/>	TCP+UDP	wan	<input type="text"/>	 Add

**New forward rule:**

Name	Source zone	Destination zone	
<input type="text" value="New forward r"/>	lan	wan	 Add and ed

In addition, traffic rule can be used for creating some access control rules, it can be from LAN to WAN, or WAN to LAN.

**New forward rule:**

Name	Source zone	Destination zone	
<input type="text" value="New forward r"/>	lan	wan	 Add and ed

Click 'Add and Edit', then you can get more detailed matching condition.

Rule is enabled Disable

Name

Restrict to address family

Protocol

Match ICMP type

Source zone

Any zone

lan: lan:

wan: wan:

Source MAC address

Source address

Source port

Destination zone

Device (input)

Any zone (forward)

lan: lan:

wan: wan:

Destination address

Destination port

Action

Extra arguments  Passes additional arguments to iptables. Use with care!

### 1) Restrict to Address Family

You can choose IPv4, IPv6, or Pv4/IPv6.

### 2) Protocol

To choose the protocol you want for access control, it can TCP, UDP or TCP/UDP.

### 3) Source MAC Address

To choose the source MAC address of data packet.

### 4) Source Address

To choose the source IP address of data packet.

### 5) Source Port

To choose the source port of data packet.

#### **6) Destination Address**

To choose the destination IP address of data packet.

#### **7) Destination Port**

To choose the destination port of data packet.

#### **8) Action**

If the above-mentioned conditions matched, then you can choose below actions.

- **Accept**

Allow data packet to go through.

- **Drop**

Drop data packet

- **Reject**

Drop data packet, and return an unachievable data packet.

- **Don't Track**

No action.

### **3.3.4 Custom Settings**

Users can also customize some firewall rules themselves, as those rules consist of iptables, we suggest only professional users who are familiar with iptables command to do this. When you add rules, please add them at the bottom of existing rules, and don't delete them.

## **3.4 VPN**

VPN is used to establish a virtual private channel, and all the data in this channel will be encrypted to ensure that data security during transmission.

TR341 support several types of VPN: PPTP, L2TP, IPSec, OpenVPN and GRE.

### **3.4.1 PPTP**

You can configure either PPTP client or PPTP server, but it can't use both of them at the same time, that may cause uncertain issues.

## 1) PPTP Client

PPTP Client  Enable  Disable

Server Address

User Name

Password  

Remote Subnet

Remote Subnet Mask

NAT

Enable MPPE Encryption

Enable Static Tunnel IP Address

Default Gateway   All Traffic Will Passthrough Via VPN

### 1. PPTP Client

You can enable or disable PPTP client.

### 2. Server Address

To enter the IP address or Domain Name of PPTP server.

### 3. User Name and Password

To enter the user name and password provided by server.

### 4. Remote Subnet

To enter the remote subnet, for example, if LAN of PPTP server is 192.168.2.1, then you can enter remote subnet 192.168.2.0.

### 5. Remote Subnet Mark

To enter the remote subnet mask, normally it is 255.255.255.0.

### 6. NAT

If click NAT, all packets come from ppp0, and the source IP of the packets will be replaced as IP of ppp0.

### 7. Enable MPPE Encryption.

You can enable MPPE encryption here.

### 8. Default Gateway

Click Default Gateway, then a default route will be established under ppp0, and all the data will go through this route.

## 2) PPTP Server

PPTP Server  Enable  Disable

Server Local IP

IP Address Range

Enable MPPE Encryption

DNS1

DNS2

WIN1

WIN2

CHAP Secrets

### 1. PPTP Server

You can enable or disable PPTP server.

### 2. Server Local IP

To enter the server local IP address.

### 3. IP Address Range

Type the range of assigned IP address.

### 4. Enable MPPE Encryption.

You can enable MPPE encryption here.

### 5. DNS1/DNS2

To enter the assigned DNS address.

### 6. WIN1/WIN2

To enter the WIN address.

### 7. CHAP Secrets

To create an username and password under CHAP Secrets, format as below,

Username<space>\*<space>password<space>\*

For example, if you want to create a username: test, password: test, it is as below,

Test \* testing \*

## 3.4.2 L2TP

You can also configure either L2TP client or L2TP server, but not both of them at the same time, as that may cause uncertain issues.

## 1) L2TP Client

### L2TP Setting

Setting L2TP

L2TP Client  Enable  Disable

Server Address

User Name

Password  

Tunnel Name

Tunnel Password  

Enable IPsec

Pre Shared Key  

Right ID

Enable Self Defined IKE

IKE Encryption Algorithm

IKE Integrity Algorithm

Diffie-Hellman Group

Enable Self Defined ESP

ESP Encryption Algorithm

ESP Integrity Algorithm

Remote Subnet   eg: 192.168.10.0

Remote Subnet Mask   eg: [255.255.255.0](#)

NAT

Enable MPPE Encryption

MTU   600~1450

Enable Static Tunnel IP Address

Default Gateway   All Traffic Will Passthrough Via VPN

Enable Ping   Reconnect When Fails to Ping



### **1. L2TP Client**

You can enable or disable L2TP client.

### **2. Server Address**

To enter the IP address or Domain Name of L2TP server.

### **3. User Name and Password**

To enter the user name and password provided by server.

### **4. Remote Subnet**

To enter the remote subnet, for example, if LAN of L2TP server is 192.168.2.1, then you can enter remote subnet 192.168.2.0.

### **5. Remote Subnet Mask**

To enter the remote subnet mask, normally it is 255.255.255.0.

### **6. NAT**

If click NAT, all packets come from ppp0, and the source IP of the packets will be replaced as IP of ppp0.

### **7. Enable MPPE Encryption.**

You can enable MPPE encryption here.

### **8. Default Gateway**

Click Default Gateway, then a default route will be established under ppp0, and all the data will go through this route.

## 2) L2TP Server

### L2TP Setting

Setting L2TP

L2TP Client  Enable  Disable

L2TP Server  Enable  Disable

Server Local IP

IP Address Range  eg: 10.10.10.100-10.10.10.200

Enable MPPE Encryption

Enable IPsec

Pre Shared Key  

NAT

CHAP Secrets  eg: test \* test \*

Client Subnet  eg: test 192.168.10.0 255.255.255.0

#### 1. L2TP Server

You can enable or disable L2TP server.

#### 2. Server Local IP

To enter the server local IP address.

#### 3. IP Address Range

Type the range of assigned IP address.

#### 4. Enable MPPE Encryption.

You can enable MPPE encryption here.

#### 5. CHAP Secrets

To create an username and password under CHAP Secrets, format as below,

Username<space>\*<space>password<space>\*

For example, if you want to create a username: test, password: test, it is as below,

Test \* test \*

### 3.4.3 OpenVPN

## OpenVPN

### Set OpenVPN Parameters

OpenVPN  Enable  Disable

Topology

Role

Protocol

Port

Device Type

OpenVPN Server

Authentication Type

CA  浏览...

Public Certificate  浏览...

Private Key  浏览...

DH  浏览...

TLS Authentication Key  浏览...

Peer Subnet Address  ? eg: 192.168.10.0

Peer Subnet Mask  ? eg: [255.255.255.0](#)

Enable NAT

Enable LZO Compress

Cipher Algorithm

MTU

#### 1) OpenVPN

You can enable or disable OpenVPN.

## **2) Topology**

Choose the topology, it can be point to point or subnet

Note: For point to point, a tunnel will be established between 2 devices.

While for subnet, multi devices will be connected to one server.

## **3) Role**

When topology is subnet, you need to choose you want it be a server or client.

## **4) Protocol**

Choose the protocol, it can be UDP or TCP, default is UDP.

## **5) Port**

Enter the port you want to assign to OpenVPN, default port is 1194.

## **6) Device Type**

Choose device type, there are 2 types to choose, TUN and TAP. TUN is layer 3 data encapsulation, while TAP is layer 2 data encapsulation.

## **7) OpenVPN Server**

When you choose server in 角色, you need to enter an IP address or domain name of server.

## **8) Authentication Type**

If topology is subnet, authentication type is certification. If it is point to point, you can choose none, certificate or static secret.

## **9) TLS Role**

When topology is point to point, and authentication type is certification, you need to choose if it is server or client.

### **3.4.4 IPSec**

On IPSEC page, system will display the IPSEC connection and status.

IPSec  Enable  Disable

Peer Address

Negotiation Method

Tunnel Type

Local Subnet

Peer Subnet

IKE Encryption Algorithm

IKE Integrity Algorithm

Diffie-Hellman Group

IKE Life Time

Authentication Type

Pre-shared Key

Local Identifier

Peer Identifier

ESP Encryption Algorithm

ESP Integrity Algorithm

DPD Timeout  seconds

DPD Detection Period  seconds

DPD Action

### 1) Peer Address

To enter peer IP address or Domain Name, if choose as a server, you don't need to enter it.

### 2) Negotiation Method

You can choose 'Main' or 'Aggressive'.

### 3) Tunnel Type

You can choose 'Site to Site', 'Site to Host', 'Host to Host', 'Host to Site'.

### 4) Local Subnet

Local subnet and mask, like 192.168.10.0/24.

### 5) Peer Subnet

Peer subnet and mask, like 192.168.20.0/24.

### 6) IKE Encryption Algorithm

IKE phase encryption method

### 7) IKE Lifetime

To set up IKE lifetime.

### 8) Local Identifier

Local identifier of channel, can be an IP address or domain name.

### 9) Peer Identifier

Peer identifier of channel, can be an IP address or domain name.

### 10) ESP Encryption Algorithm

The encryption method of ESP.

## 3.4.5 GRE

Interface Name eg: gre1	Peer WAN IP	Peer Tunnel IP	Peer Subnet eg:192.168.1.0/24	Local Tunnel IP	
<input type="text"/>	<input type="text"/>	<input type="text"/>	<input type="text"/>	<input type="text"/>	Delete

## 3.5 Advanced

Advanced menu include some advanced functions for your usage, like send SMS, traffic monitor, GPS location, SNMP, etc.

### 3.5.1 Send SMS

TR341 provide window for sending out Short Message to certain numbers with configurable content.

**Send Short Message**

Phone Number

Please Input The Content

### 3.5.2 Static Routing

Static routing is used to add a routing table entry.

Interface	Target	IPv4-Netmask	IPv4-Gateway	Metric	
	Host-IP or Network	if target is a network			
lan	<input type="text"/>	255.255.255.2	<input type="text"/>	0	<input type="button" value="Delete"/>

**Interface:** To choose which interface you want to add routing.

**Target:** Can be a host IP, or subnet.

**IPv4 Netmask:** The netmask of subnet, if the target is host, the netmask shall be 255.255.255.255.

**IPv4 Gateway:** The address of next-hop gateway address.

Note: this address shall be achievable, or you'll fail to add static routing.

### 3.5.3 Net Flow

The traffic meter function of TR341 is for traffic statistics from WAN port, meanwhile, it has traffic overflow alarm function. Even if the router is powered off, the traffic statistics will be saved, and when you power on the router, the traffic will be counted based on your last time traffic.

#### Net Flow

Traffic Meter

Current Day Flow	Current Month Flow
0.0G	0.0G

Net Flow

Net Flow  Enable  Disable

Limit Enabled

Day Limit  M

Month Limit  M

Clear Day Flow

Clear Month Flow

### 3.5.4 GPS Location

GPS location will report GPRMV information regularly, saying longitude and latitude information. And this function is used for accurate location of outdoor open area.

> **View**

> **Setup**

> **Secure**

> **VPN**

> **Advanced**

- Send SMS
- Static Routes
- Net Flow
- GPS Location**
- BS Location
- Dynamic DNS
- SNMP
- DHCP and DNS

> **Data Collect**

> **Administrate**

Logout

## GPS Location

GPS Location  Enable  Disable

GPS Source  External  Dongle

Output Mode

Server Address

Server Port

Report Mode

User Defined Register Packet  ⓘ Max 128 Bytes ASCII

User Defined Heartbeat Packet  ⓘ Max 128 Bytes ASCII

Report Interval  ⓘ Seconds

Heartbeat Interval  ⓘ Seconds

GPS Info

Connection Status

**GPS Source:** External for getting GPS data from independent GPS module (Option), while Dongle for getting GPS data from cellular module which may not so accurate.

**Output Mode:** Output to network, or output to serial which through RS232 port.

**Server Address:** The IP address of server that receive GPS data if the output mode as “Output to Network”, which is based on TCP or UDP connection.

**Server Port:** The port of server.

**Report Interval:** The interval time for auto report of router location, default value is 60 seconds.

### 3.5.5 BS Location (Option)

Base station location is to locate the TR341 by obtaining the nearest base station number, this function is mainly for rough location of indoor application.

Enter the server IP address and port that you want to report the location of router, then router will auto report its location to server regularly(within the interval time you set).



BS Location  Enable  Disable

Server Address

Server Port

Report Interval   Seconds

**Server Address:** The IP address of server that you want the router to report the location, which is based on TCP connection.

**Server Port:** The port of server.

**Report Interval:** The interval time for auto report of router location, default value is 60 seconds.

### 3.5.6 Dynamic DNS

If the assigned public IP address of router is dynamic and changes frequently, you can enable DDNS function, while allows you to register a domain to bundle with the IP address, in this case, no matter what the IP address changed, it will direct to your registered domain.

DDNS  Enable  Disable

Service Type

User Name

User Password  

Host Name

- **Service Type**

There are several types of DDNS service supported in router, as below.

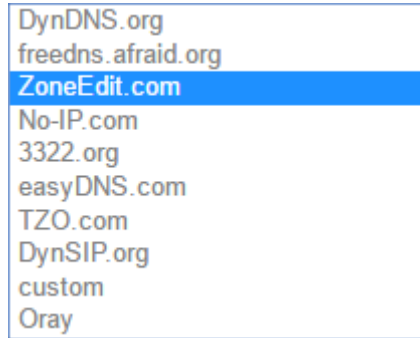

- **User Name**

The username you register at DDNS service provider.

- **User Password**

The password you set up when registering the user name at DDNS service provider.

- **Host Name**

The register domain you want to bundle.

### 3.4.6 SNMP

TR341 router provide SNMP feature for manage the device via SNMP. Configure the relevant settings accordingly.

## SNMP Setting

### SYSTEM

Enable	<input type="text" value="Enable"/>
Location	<input type="text" value="Unknown"/>
Contact	<input type="text" value="root"/>
Name	<input type="text" value="top-iot"/>

### RO/RW Community

#### PUBLIC

Security Name	<input type="text" value="ro"/>
Source Address	<input type="text" value="default"/>
Community	<input type="text" value="public"/>

#### PRIVATE

Security Name	<input type="text" value="rw"/>
Source Address	<input type="text" value="localhost"/>
Community	<input type="text" value="private"/>

### 3.5.7 DHCP and DNS

TR341 provide DHCP and DNS setting via Dnsmasq package, it support configure DHCP server related settings and DNS forwarding setting if your network request specific parameters. Also support set static Leases. Normally leave it as default.

## DHCP and DNS

Dnsmasq is a combined [DHCP-Server](#) and [DNS-Forwarder](#) for [NAT](#) firewalls

### Server Settings

General Settings **Resolve and Hosts Files** TFTP Settings Advanced Settings

Domain required  [?](#) Don't forward DNS-Requests without DNS-Name

Authoritative  [?](#) This is the only DHCP in the local network

Local server  [?](#) Local domain specification. Names matching this domain are never forwarded and are resolved from DHCP or hosts files only

Local domain  [?](#) Local domain suffix appended to DHCP names and hosts file entries

Log queries  [?](#) Write received DNS requests to syslog

DNS forwardings  [?](#) List of DNS servers to forward requests to

Rebind protection  [?](#) Discard upstream RFC1918 responses

Allow localhost  [?](#) Allow upstream responses in the 127.0.0.0/8 range, e.g. for RBL services

Domain whitelist  [?](#) List of domains to allow RFC1918 responses for

### Active DHCP Leases

Hostname	IPv4-Address	MAC-Address	Leasetime remaining
----------	--------------	-------------	---------------------

Collecting data...

### Static Leases

Static leases are used to assign fixed IP addresses and symbolic hostnames to DHCP clients. They are also required for non-dynamic interface configuration where only hosts with a corresponding lease are served.

Use the *Add* Button to add a new lease entry. The *MAC-Address* identifies the host, the *IPv4-Address* specifies the fixed address to use and the *Hostname* is assigned as symbolic name to the requesting host.

Hostname	MAC-Address	IPv4-Address	IPv6-Suffix (hex)
----------	-------------	--------------	-------------------

This section contains no values yet

[+](#) Add

[Save & Apply](#) [Save](#) [Reset](#)

## 3.6 Data Collect

Data Collect settings is for TR341 acquiring data from slave devices in serial ports, Ethernet ports, with Modbus protocol and other customized protocols.

### 3.6.1 Basic Setting

Enable or Disable the data collect feature, setting the data acquire and report period and other related options.

**Basic Setting**

Data Collect  Enable  Disable

Collect Period  Seconds

Report Period  Seconds

Enable Cache  Cache History Data

Cache Days  day

Cache Path  Path Where Data Is Stored

Send Minute Data

Send Hour Data

Send Day Data

Save & Apply Save Reset

- 1) Data Collect: Enable or Disable data collect feature.
- 2) Collect Period: Set the period of data acquire from slave devices.
- 3) Report Period: Set the Period of data report to server.
- 4) Enable Cache: Enable or Disable history data cache feature.
- 5) Related data cache setting if enable the cache feature.

### 3.6.2 Interface Setting

Switch the hardware interfaces for data acquisition from kinds of slave devices. Including Serial ports (COM1~COM2), Modbus TCP base on Ethernet LAN, GPS Device.

- > View
- > Setup
- > Secure
- > VPN
- > Advanced
- > Data Collect
    - Basic Setting
    - Interface Setting
    - Modbus Rules Setting
    - Server Setting
- > Administrate
- Logout

## Interface Setting

COM1/RS485
COM2/RS232

Enabled  Enable  Disable

Baudrate

Databit

Stopbit

Parity

Frame Interval  ms

COM Protocol

## Modbus TCP Server Setting

Modbus Server1
Modbus Server2
Modbus Server3
Modbus Server4
Modbus Server5

Enabled  Enable  Disable

Server Address

Server Port

Transaction ID  0-65535

Protocol ID  0-65535

## GPS Device

Must Enable GPS On Page Advanced/GPS Location First

GPS  Enable  Disable

### 3.6.3 Modbus Rules Setting

Modbus Rules Setting is for TR341 as a Modbus master to acquire data from slave devices base on Modbus protocol. You can configure unlimited Modbus rules on it. TR341 provide the options of definable factor name, device ID, function code, register address and count register number, please following the slave device datasheet to get those information.

[View](#)  
[Setup](#)  
[Secure](#)  
[VPN](#)  
[Advanced](#)  
[Data Collect](#)  
 Basic Setting  
 Interface Setting  
**Modbus Rules Setting**  
 Server Setting  
[Administrate](#)  
[Logout](#)

## Modbus Rules Setting

Modbus Rules

Order	Device Name	Interface	Factor Name	Device ID	Function Code	Start Address	Count	Data Type	Reporting Center	Enable	
1	PH_sensor	COM1	temperature	1	4	0	1	unsigned 16Bits AB	1	<input checked="" type="checkbox"/>	<a href="#">Edit</a> <a href="#">Delete</a>

New Modbus Rule

Order	Device Name	Interface	Factor Name	Device ID	Function Code	Start Address	Count	Data Type	Reporting Center	
<input type="text"/>	<input type="text"/>	COM1	<input type="text"/>	0~255	0~255	0~65535	1~120	Unsigned 16Bits	1-2-3-4-5	<a href="#">Add</a>

Click "Edit" button for more details setting,

### Modbus Rules - PH\_sensor - COM1

enabled

Order

Device Name

Belonged Interface

Factor Name  [?](#) Multiple Factors Are Separated By Semicolon

Alias Name  [?](#) Multiple Aliases Are Separated By Semicolon

Device ID  [?](#) 0~255

Function Code  [?](#) 0~255

Start Address  [?](#) 0~65535

Count  [?](#) 1~120

Data Type  [?](#) A highest byte

Reporting Center  [?](#) Multiple Servers Are Separated By Minus

Unit  [?](#) Multiple Units Are Separated By Semicolon

Operator  [?](#) 0 + - \* /

Operand

Accuracy  [?](#) 0~6

### 3.6.4 Server Setting

Server setting menu allows user set the data center address with multiple protocols, the standard TR341 support TCP, UDP, HTTP, MQTT, and Modbus TCP. For the data format,

TR341 support different Encapsulation type, include “Transparent”, “Json”, and “HJ212” (special for some Environment SCADA). Also TR341 accept customize specific protocols for your data center.

- > View
- > Setup
- > Secure
- > VPN
- > Advanced
- > Data Collect
  - Basic Setting
  - Interface Setting
  - Modbus Rules Setting
  - Server Setting
- > Administrate

Logout

## Server Setting

Server1 Settings | **Server2 Settings** | Server3 Settings | Server4 Settings | Server5 Settings

Enabled  Enable  Disable

Protocol

Encapsulation Type

Server Address

Server Port

MQTT Public Topic

MQTT Subscribe Topic

MQTT Username

MQTT Password

Client ID

Enable TLS/SSL

Certificate Type

Enable Self Defined Variable

## 3.7 Administrate

Administrate page provide the administrator level setting for system, like password setting, Timezone setting, Backup and Reset setting, etc.

### 3.7.1 System

System page provide the basic system information setting like Hostname, Timezone, Language, etc.



- > View
- > Setup
- > Secure
- > VPN
- > Advanced
- > Data Collect
- ▼ Administrate
  - System
  - Password
  - Time Setting
  - Log Setting
  - Backup and Restore
  - Router Upgrade
  - Remote Configured
  - Manual Reboot
  - Schedule Reboot
- Logout

## System

Here you can configure the basic aspects of your device like its hostname or the timezone.

### System Properties

Hostname	<input type="text" value="router"/>
Timezone	<input type="text" value="(GMT+08:00) Beijing, Chongqin"/>
Language	<input type="text" value="English"/>
SMS Varyify Password	<input type="text" value="admin"/>
Web Access Method	<input type="text" value="HTTP"/> <span style="font-size: x-small;">Need Reboot When Changed</span>

Enable telnet access  Enable  Disable

Enable SSH access  Enable  Disable

### 3.7.2 Password

To revise the password of router.

### Admin Password

Change the password of the system administrator (User root)

Origin Password	<input type="password" value="....."/>	
Password	<input type="password"/>	
Confirmation	<input type="password"/>	

### 3.7.3 Time Setting

System time type includes RTC (Real Time Clock) and NTP (Network Time Protocol). RTC will save time even router is powered off, while for NTP, router will connect to NTP server which requires internet connection, time won't be saved once powered off. But NTP will be more accurate than RTC, and you may need to adjust the time manual if it is not accurate.

## Set System Time

Current system time 2021-03-19 15:24:14

System Time Type  ntp  rtc

Current RTC Time 2021-03-19 15:24:14

RTC Date  [?](#) eg: 2016-01-01

RTC Time  [?](#) eg: 12:00:00

### 1) Current System Time

Display the time of router.

### 2) System Time Type

It includes NTP and RTC mentioned above, and different type has different configuration parameters

- **RTC**

You can update data and time yourself.

RTC Date  [?](#) eg: 2016-01-01

RTC Time  [?](#) eg: 12:00:00

#### RTC Data

Format must be: 20xx-xx-xx (Year-Month-Day), or you will fail to update it.

#### RTC Time

Format must be xx: xx: xx (Hour-Min-Second), or you will fail to update it.

- **NTP**

NTP Time Server  [?](#)

Port

Update Interval  [?](#) seconds

#### NTP Time Server

You can select the NTP time server through drop-down menu, or you can customize it yourself.

#### Port

NTP time server port, default port is 123.

## Update Interval

How long to sync the time with NTP server, default time is 600 seconds.

### 3.7.4 Log Settings

Log settings is for configuring the output parameters of system log.

Output To Device	<input type="text" value="/var/log/"/>
Log Size	<input type="text" value="64"/> KB
Log Server	<input type="text" value="0.0.0.0"/>
Log Server Port	<input type="text" value="514"/>
Output Level	<input type="text" value="Debug"/>

#### 1) Output to Device

You can output the log to serial port, or specified file path, or external storage device, and the default path is:/var/log/

#### 2) Log Size

Set up the size of log, default value is 64KB.

#### 3) Log Server

Set up the IP address of log server.

#### 4) Log Server Port

Set up the port of log server, default value is 514

#### 5) Output Level

There are several levels supported, including 'Debug', 'Info', 'Notice', 'Warning', 'Error', and level increased in sequence, the higher level, the less output log.

### 3.7.5 Backup and Reset

User can either backup the configuration of router as a .gz file, or reset all settings to factory defaults.

#### Backup / Restore

Click "Generate archive" to download a tar archive of the current configuration files. To reset the firmware to its initial state, click "Perform reset" (only possible with squashfs images).

Download backup:

Reset to defaults:

To restore configuration files, you can upload a previously generated backup archive here.

Restore backup:  未选择文件。

#### 1) Download Backup

Click to generate a configuration file in format of "backup-router-2016-\*\*-\*\*.tar.gz".

#### 2) Reset to Default

Click 'Perform Reset', and a pop-up confirmation box with 'Really Reset All Changes' will display, then click 'OK' to reset to factory defaults.

#### 3) Restore Backup

To restore configuration files, you can upload a previously generated backup archive here.

Restore backup:

After reset to default, you can also upload the saved configuration file to router, to recover the previous configuration. Click 'upload archive', select and upload the backup configuration file, and a pop-up confirmation box with 'Really Restore' will display, then click 'OK', to recover the configuration.

### 3.7.6 Firmware Upgrade

Router upgrade page provide upgrade firmware via webUI. Before upgrade the firmware for router, please ensure the firmware you're planning to upload is correct one, otherwise that may cause device crash.

## Flash operations

### Flash new firmware image

Upload a sysupgrade-compatible image here to replace the running firmware. Check "Keep settings" to retain the current configuration (requires an OpenWrt compatible firmware image).

Image:  未选择文件。

## 1) Choose and Upload Firmware Image

Click 'browse' and select the firmware, then click 'Flash Image', and firmware will be upload to router. Then you'll go to below page.

### Flash Firmware - Verify

The flash image was uploaded. Below is the checksum and file size listed, compare them with the original file to ensure data integrity.

Click "Proceed" below to start the flash procedure.

Checksum: `f68983dbe5ec7f0d4bf9258e421ad53d`

Size: 9.00 MB

Configuration files will be kept.

- **Checksum**

MD5 checksum value of firmware.

- **Size**

The size of firmware.

- **Proceed**

Click 'proceed' to start the firmware upgrade, or click 'cancel' to stop the firmware upgrade.

## 3.7.7 Remote Management

Remote Management feature allows TR341 **connect with Bivocom Device Management Platform** identify by Device Number for remote management, like firmware upgrade, configuration change, etc.

You can configure the IP address and port of remote DMP server, device number and phone number of router, etc., as below.

- > View
- > Setup
- > Secure
- > VPN
- > Advanced
- > Data Collect
- ▼ Administrate
  - System
  - Password
  - Time Setting
  - Log Setting
  - Backup and Restore
  - Router Upgrade
  - Remote Configured
  - Manual Reboot
  - Schedule Reboot
- Logout

## Remote Configured

Remote Configured  Enable  Disable

Server Address

Server Port

Heart Interval

Device Number

Connection Status Registered

Once it registered, on the Bivocom Device management platform, you will see the connection status as “Online” and you can configure it via DMP webUI.

The screenshot shows the 'Device List' page in the Bivocom DMP webUI. The interface includes a sidebar with navigation options like 'Device Management', 'Statistical Analysis', and 'System Management'. The main content area displays a table of registered devices. The first device, ID 20210319, is highlighted with a pink arrow. The table columns include Device ID, Device Name, Device Type, Device Model, SIM Card, Carrier, Online Status, Network Type, Signal, Latest Online Time, Remarks, and Operations.

Device ...	Device ...	Device ...	Device ...	SIM Car...	Carrier	Online ...	Networ...	Signal	Latest Online Time	Remarks	Operati...
20210319	Bivocom ...	Router	TR321	1391234...	Telecom	Online	Wired	--	2021-03-19 15:53:50	--	🗑️
20200911	TG452	Data acq...	TG452	1234567...	Unicom	Outline	--	--	2021-01-19 16:19:34	test	🗑️
20200918	TR321	Router	TR321-LF	1865001...	Unicom	Outline	--	--	2020-10-23 16:34:17	Demo	🗑️
10000001	45454	Router	TJ710	1896545...	Telecom	Outline	--	--	2020-09-12 17:04:30	1000	🗑️

### 1) Server Address

Type the specified login server address you want to remote manage the router, it can be either an IP address or Domain Name.

### 2) Server Port

The specified login server port.

### 3) Heartbeat Interval

The heartbeat time interval (Unit: second)

#### 4) Device Number

Define an individual Device ID for router and as identify on DMP.

### 3.7.8 Manual Reboot

#### Reboot

Reboots the operating system of your device

Warning: There are unsaved changes that will be lost while rebooting!

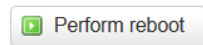
 Perform reboot

Click 'Perform Reboot', and a pop-up confirmation box with 'Really Reboot' will display, then click 'OK' to reboot the router.

### 3.7.9 Schedule Reboot

Schedule reboot feature allow you preset the rules of device reboot, by period interval or by a certain time point.

#### Schedule Reboot

Enable Schedule Reboot  Enable  Disable

Schedule Type  By Period  By Time

Period Interval   Minutes, Min 5

### 3.8 Logout

Click the Logout menu to logout the webUI of TR341.